



16

Technical Appendix

**The technical information guide
for our entire product range**

16.1 Professional Installation of Hoses

The length of certain hose types may alter due to the influence of variable factors such as pressure, vacuum, media temperature and ambient temperature. This must be taken into account when installing hoses in order to prevent mechanical damage. Case studies are in accordance with DIN 20 066, section 4.

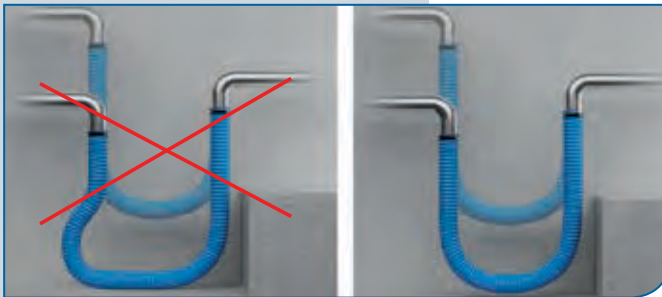

Example 1

Arrange hoses as freely suspended bends so that they do not come into contact with either the wall, the ground or with other objects when extended.

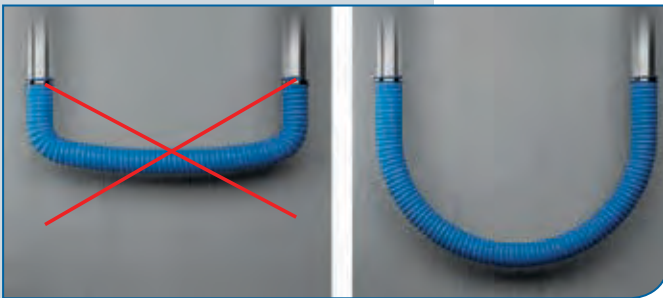

Example 2

Install hoses as a 180° bend allowing sufficient straight ends on the hoses. Determine the installation length in accordance with the required bend radius.

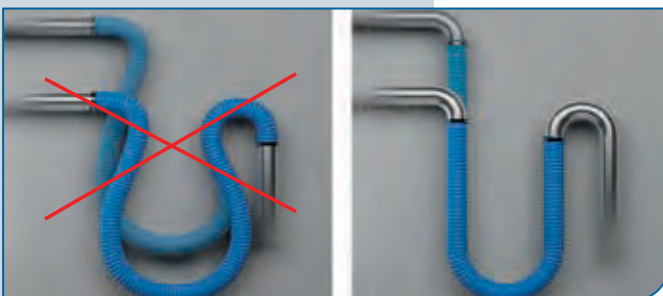

Example 3.1

Non-permitted bends directly adjacent to the connection fittings should always be avoided. The minimum bending radius should be observed at all times.

Example 3.2

Install hoses with sufficient length. The required bending radius should be observed.

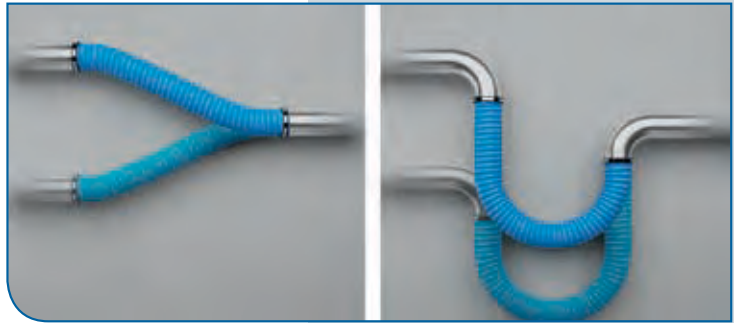

Example 4

The direction of movement and the hose axis must be on the same level. This prevents potential torsional strain damage.

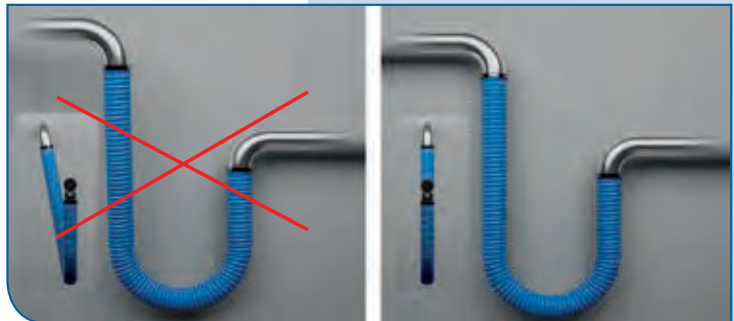

Example 5

Slight lateral movements are permissible.



16.2 Cutting Masterflex Hoses to Length

16.2.1 Professional trimming of hoses with a clip helix (all Master-Clip hose types, as well as Carflex 200 and Carflex 300)

First, cut the helix (clip) using wire cutters.



Using a sharp knife, cut the hose material through to both adjacent helices.



Finally, cut the hose material cleanly along the clip helix.



16.2.2 Instructions for the Grounding of Clip-Hoses

For the transport of flammable dust particles and bulk solids, hoses must meet special demands to avoid any danger of ignition. Antistatic or electrically conductive hose versions are often applied. In order to guarantee

Take the end of the hose and place it on a non-slip surface.

Cut the wall material to approx. 30 mm along the metal clip helix spiral.

Peel the end of the metal helix, so that it is free from the wall material. Remove the material with a sharp instrument. Please ensure that you cut away from your body, in order to avoid any injuries.

Bend the metal clip profile forward at a 90° angle to the hose.

optimum safety with regards to avoiding electrostatic ignition hazards, the correct grounding of the hoses during assembly and installation is imperative. In this case, the metal helix must be grounded on both sides of the hose.



16.3 Pressure & Vacuum Behaviour of Masterflex Hoses



Remove any remaining material from the metal clip profile.



Now attach the hose connection clamp.
Push the hose onto the pipe.



Now attach the appropriate clamp and pull tight so that the metal clip profile is pressed firmly onto the pipe and the hose is fixed in place. There must be contact between the metal clip profile and the pipe.

As is shown in images 8 - 9, the metal clip profile sits on the pipe and is fixed in place by the separate clamp, metal on metal. This type of connection is recommended. Other methods of grounding are also possible, however, we would like to point out the following:

Excerpt from Regulation EN 60335-1:2002-A2:2006
Electrical connections and grounding conductors must be carried out in such a way that the contact pressure is not transferred via insulation material, which may shrink or become deformed.

An exception applies if the metal parts possess enough elasticity to compensate any shrinking or deformation of the insulation material.

Metal screws may only be applied for electrical connections if the parts clamp together. Thread-cutting screws and thread-forming screws may only be applied for electrical connections if they create a fully-formed standard thread.

16.2.3 Instructions for the Grounding of Hoses

For the transport of flammable dust particles and bulk solids, hoses must meet special demands to avoid any danger of ignition. Antistatic hose versions are often applied, as these contain a permanent antistatic agent as an additive, which offers both permanent electrical conductivity as well as adherence to international food

Take the end of the hose and place it on a non-slip surface

Cut the wall material to approx. 30mm along the helix spiral

Peel the end of the wire, so that it is free from the wall material. Remove the plastic with a sharp instrument. Please ensure that you cut away from your body, in order to avoid any injuries.

Bend the wire 90° outwards

industry standards. However, in order to guarantee optimum safety with regards to avoiding electrostatic ignition hazards, the correct grounding of the hoses during assembly and installation is imperative. In this case, the metal helix must be grounded on both sides of the hose. These instructions are designed to help you do this quickly and easily. Please follow the instructions accordingly to ground your hoses correctly and safely.

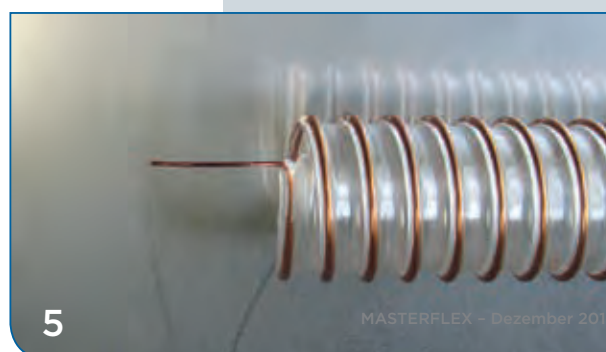
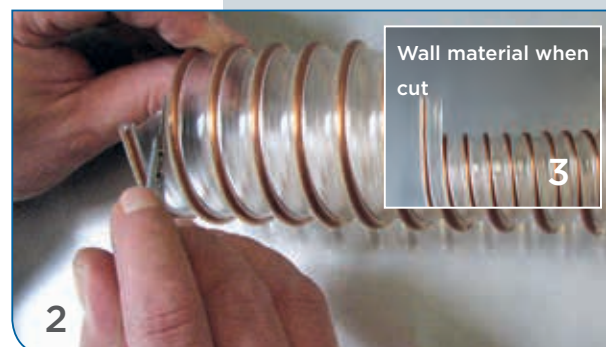

16.3 Pressure & Vacuum Behaviour of Masterflex Hoses

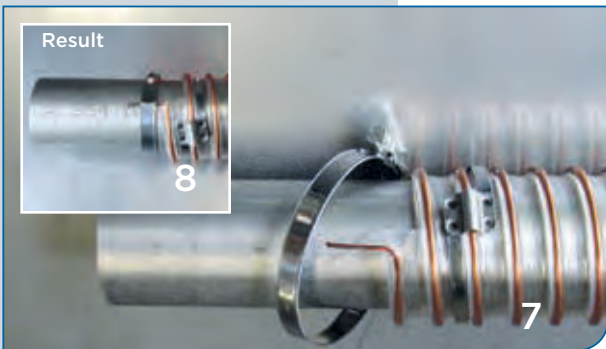
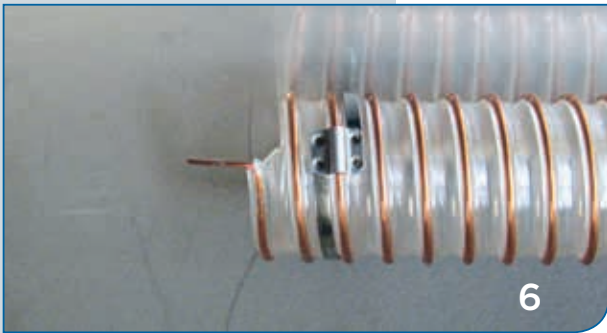

As is shown in images 8-10, the wire sits on the pipe and is fixed in place by the separate clamp, metal on metal. This type of connection is recommended. Other methods of grounding are also possible, however we would like to point out the following:

Excerpt from Regulation EN 60335-1:2002-A2:2006
Electrical connections and grounding conductors must be carried out in such a way that the contact pressure is not transferred via insulation material, which may shrink or become deformed.

Now attach the hose connection clamp

Push the wire connection clamp and the hose onto the pipe. Now pull the clamps tight so that the wire is pressed firmly onto the pipe and the hose is fixed in place. There should be contact between the wire and the pipe

Image: Tightened wire connection clamp and hose clamp with screw/worm drive, clamping range 40-60 (Art. No.: 620-040-100) as well as tightened hose connection clamp Master-Grip Clamp DN 50 (Art. No.: 533-050-100).

Image: Tightened wire connection clamp and hose clamp with bolts.
Clamping range 52-55 (Art. No.: 621-052-115)

An exception applies if the metal parts possess enough elasticity to compensate any shrinking or deformation of the insulation material.

Metal screws may only be applied for electrical connections if the parts clamp together.

Thread-cutting screws and thread-forming screws may only be applied for electrical connections if they create a fully-formed standard thread.

1
2
3
4
5
6
7
8
9
10
11
12
13
14
15
16

16.2.2 Professional trimming of hoses with integrated reinforcement helix

Using a sharp knife, cut the hose material through to both adjacent reinforcement spirals.



Pull both ends of the hose apart and cut the reinforcement helix using wire cutters.



The hose should now look like this.



Finally, cut off the hose material cleanly along the reinforcement spiral.

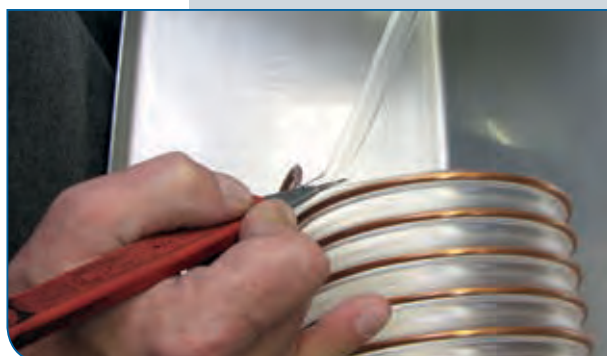

16.3 Pressure & Vacuum Behaviour of Masterflex Hoses

General

All catalogue details are the result of internal tests and experimentation in accordance with international standardisation recommendations and relate to a media and ambient temperature of + 20 °C. Different temperatures may alter the pressure and vacuum details. Depending on the construction design, the effects of the pressure, vacuum, media temperature and ambient temperature may alter the length of certain hose types. This change in length must be taken into account by the user during operation. (See also Chapter 16.1 “Professional Installation of Hoses”).

Operating Pressure

The operating pressure is the maximum permitted overpressure of a hose, at which it can be used. The definition of the operating pressure is in accordance with DIN EN ISO 7751.

Test Pressure

The test pressure is up to 50 % above the operating pressure, depending on the hose construction design. At test pressure, the hose must not have any leaks and/or permanent deformations. The definition of the test pressure is in accordance with DIN EN ISO 7751.

Burst Pressure

The burst pressure is the pressure at which the hose is destroyed. The burst pressure is used to determine the operating pressure taking into account the usual safety factors. The definition of the burst pressure is in accordance with DIN EN ISO 7751.

Vacuum (Negative Pressure)

The definition of the vacuum details for Masterflex hoses is in accordance with DIN 20024, point 15.

Testing the Vacuum Resistance

During the vacuum tests, the hoses are placed in a 90° arc in compliance with the minimum bending radius. Vacuum is then applied until they show signs of indentations or collapse. The permitted vacuum in continuous operation is determined by taking into account the usual general safety factors.

16.4 Pressure Loss of Masterflex Hoses

16.4 Pressure Loss of Masterflex Hoses

16.4.1

Pressure loss of hoses in extended form

The pressure loss is the air resistance in a hose or pipe system. When planning and installing a ventilation system, the unavoidable air resistance must be taken into account. In order to simplify the determination of the specific pressure loss for the Masterflex hoses, please refer to the following diagrams to. The details are mean values for hoses in their extended form at 20°C.

Diagram 1

DN 25 - DN 500 for the following hose types:

- Master-PE L-EL
- Master-PUR L (also: L-A se, L-MHR, L Food, L Food A, L-EL)
- Master-PUR H (also: H-A se, H-MHR, H Food, H Food A, H-EL)
- Master-PUR HÜ
- Master-PUR HX (also: HX Food, HX Food A, HX-EL)
- Master-PUR HX-S
- Flamex B se
- Flamex B-H se
- Master-PVC L
- Master-PVC H
- Master-SANTO L (also: L-AR, L se)
- Master-SANTO H (also: H-AR, H se)
- Polderflex
- Inline
- Master-NEO 2
- Master-SIL 2
- Master-SIL HD Food, SD Food

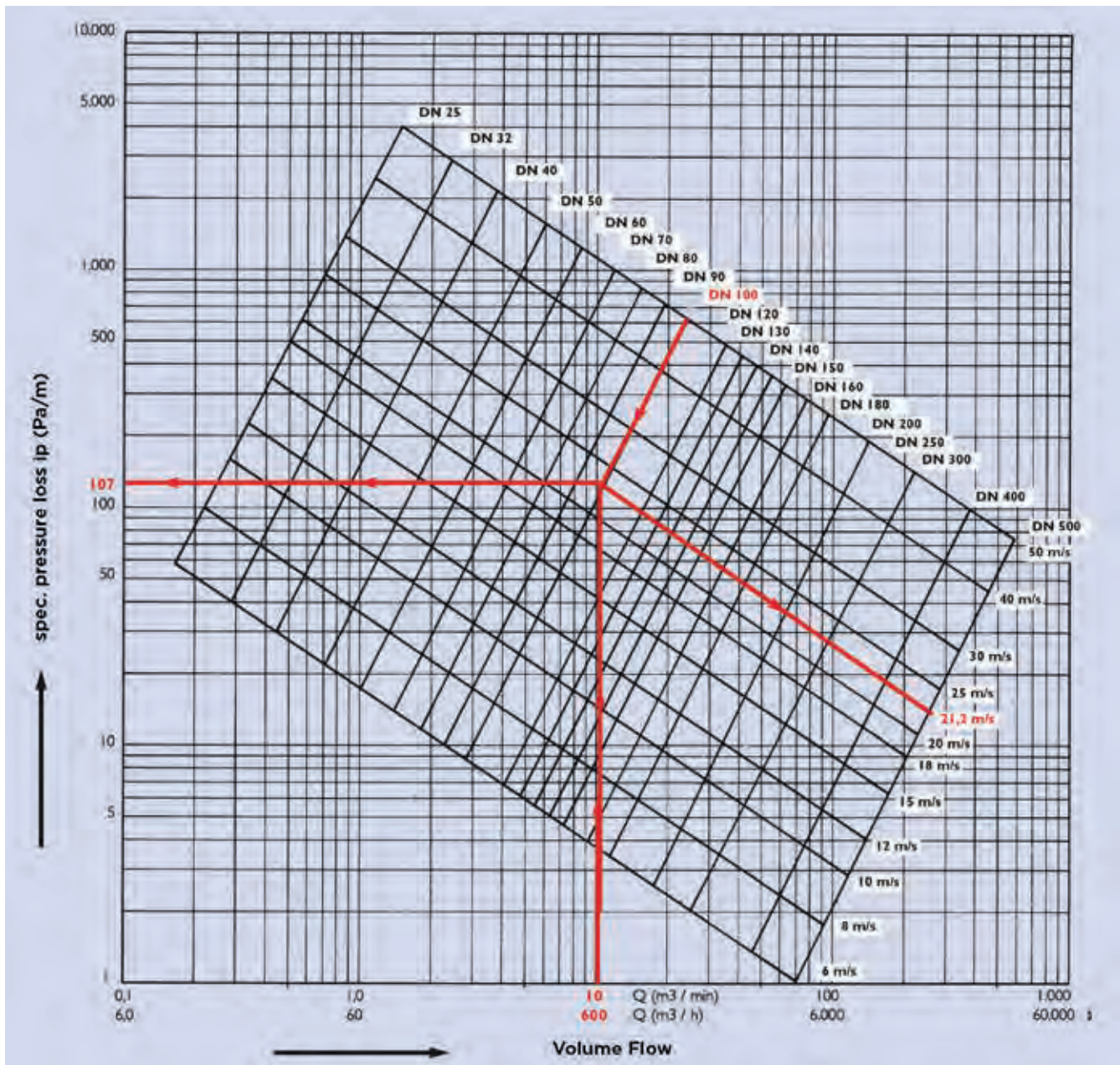

16.4 Pressure Loss of Masterflex Hoses

Diagram 2

DN 25 - DN 500 ribbed for the following hose types:

- Cargoflex
- Flamex B-F se
- Master-PVC L-F
- Master-PVC H-F
- Master-PUR L-F Food
- Miniflex PU (also: PU-AE)
- Miniflex PVC
- Miniflex TPV se
- Master-VAC
- Master-PVC FLEX
- Streetmaster GKS
- Streetmaster GKH
- Streetmaster KKS
- Streetmaster GLG
- Master-NEO 1
- Master-SIL 1
- Carflex Super
- Master-SANTO SL
- Master-PUR STEP

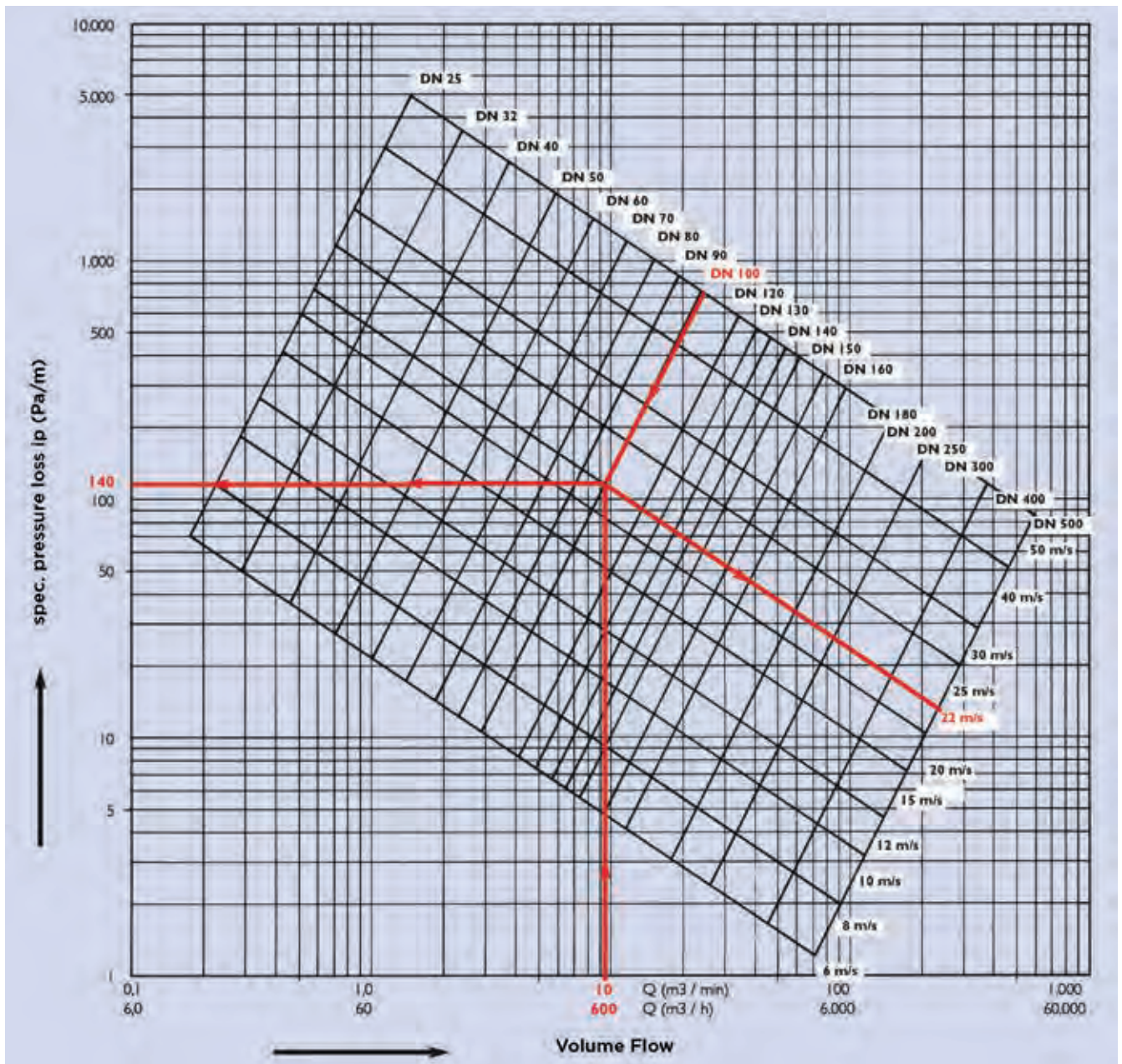

16.4 Pressure Loss of Masterflex Hoses

Diagram 3

DN 38 - DN 900

for the following hose types:

- Master-VENT 2
- Carflex 200
- Carflex 300
- all Master-Clip hoses except scaled hose construction designs

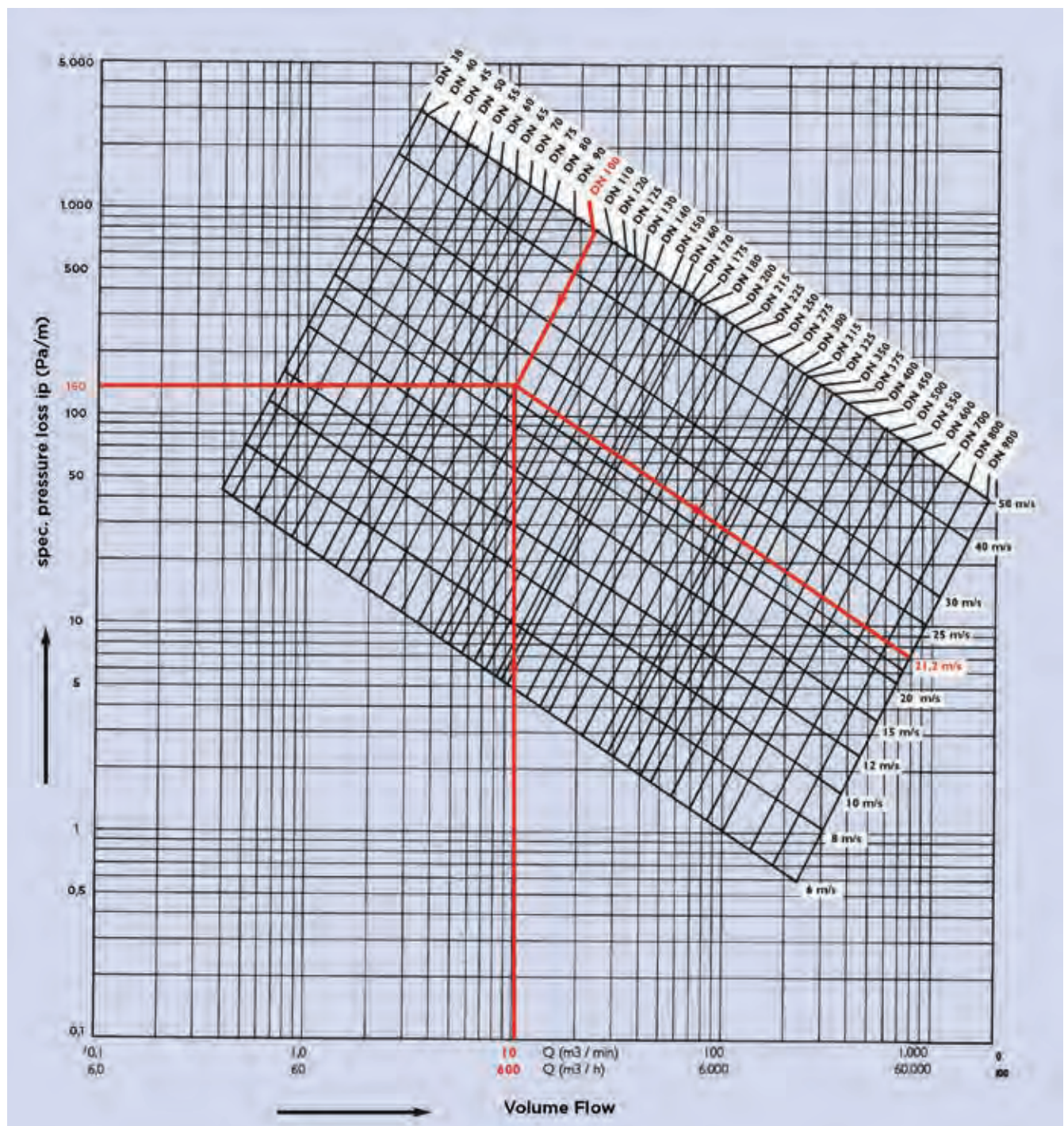

16.4 Pressure Loss of Masterflex Hoses

16.4.2

Pressure loss in hose bends

In addition to the specific pressure losses of hoses in extended form, the pressure loss in the hose bends can be determined using the following formula:

$$\Delta p_v = \zeta \frac{\rho \cdot v^2}{2} \left[\frac{N}{m^2} \right] \text{Pa}$$

(Rho) ρ = Density of medium (for air at 1013,2 mbar and $t = 20 \text{ }^\circ\text{C}$: 1,21 kg/m³)

v = flow rate m/s

(Zeta) ζ = resistance coefficient for hose bends

For circular arc bends $\zeta = 90^\circ$

R/d	1	2	4	6	10
ζ_{90°	0.36	0.22	0.17	0.13	0.15

Factor K for circular arc bends $\neq 90^\circ$:

$$\zeta = \zeta_{90^\circ} \cdot K$$

ζ	30°	60°	90°	120°	150°	180°
K	0.4	0.7	1.0	1.25	1.5	1.7

Example calculation:

Hose type:	Master-PUR L
Air flow:	10 m ³ /min.
Hose DN:	100
Flo rate (from diagram I):	21,2 m/s
Specific pressure loss (from diagram I):	107 Pa/m
Pipe/Hose length:	L = 10 m
• 1 x 180° bend at bending radius	R = 400
• 1 x 90° bend at min. permissible bending radius	
(R = DN : 2 + perm. bending radius)	R = 160

(Bend radius / DN) 4 → $\zeta = 0.17$
 (Bend radius / DN) 2 → $\zeta = 0.22$

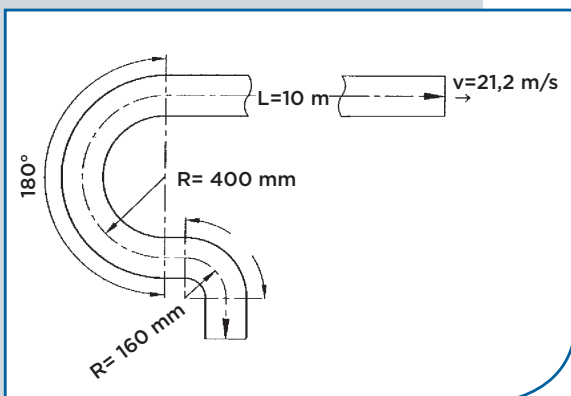
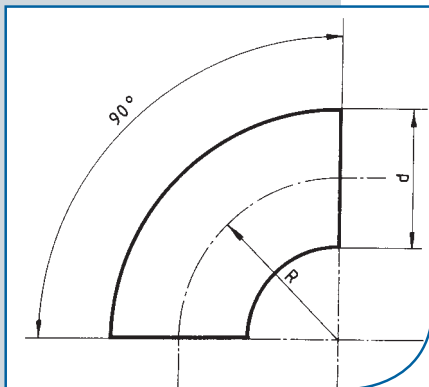

$$\begin{aligned} \Delta P_{\Sigma} &= (L \cdot \Delta P_{\text{Diagramm}}) + \frac{\zeta_{90^\circ\text{-Bogen}} \cdot \rho \cdot v^2}{2} + \frac{\zeta_{180^\circ\text{-Bogen}} \cdot \rho \cdot v^2}{2} \\ &= (L \cdot \Delta P_{\text{Diagramm}}) + \left[\zeta_{90^\circ} + (\zeta_{90^\circ} \cdot K) \right] \cdot \frac{\rho \cdot v^2}{2} \\ &= (10 \cdot 107) + \left[0,22 + (0,17 \cdot 1,7) \right] \cdot \frac{1,21 \cdot 21,2^2}{2} \\ &= 1208,5 \text{ Pa} \end{aligned}$$

16.5 Installation Aid for Hoses

16.5 Installation Aid for Hoses

Where there are two known design parameters, the third point can be read off through a straight line at the intersection of the third parameter line.

Q = volume flow rate

d = hose DN

v = flow rate

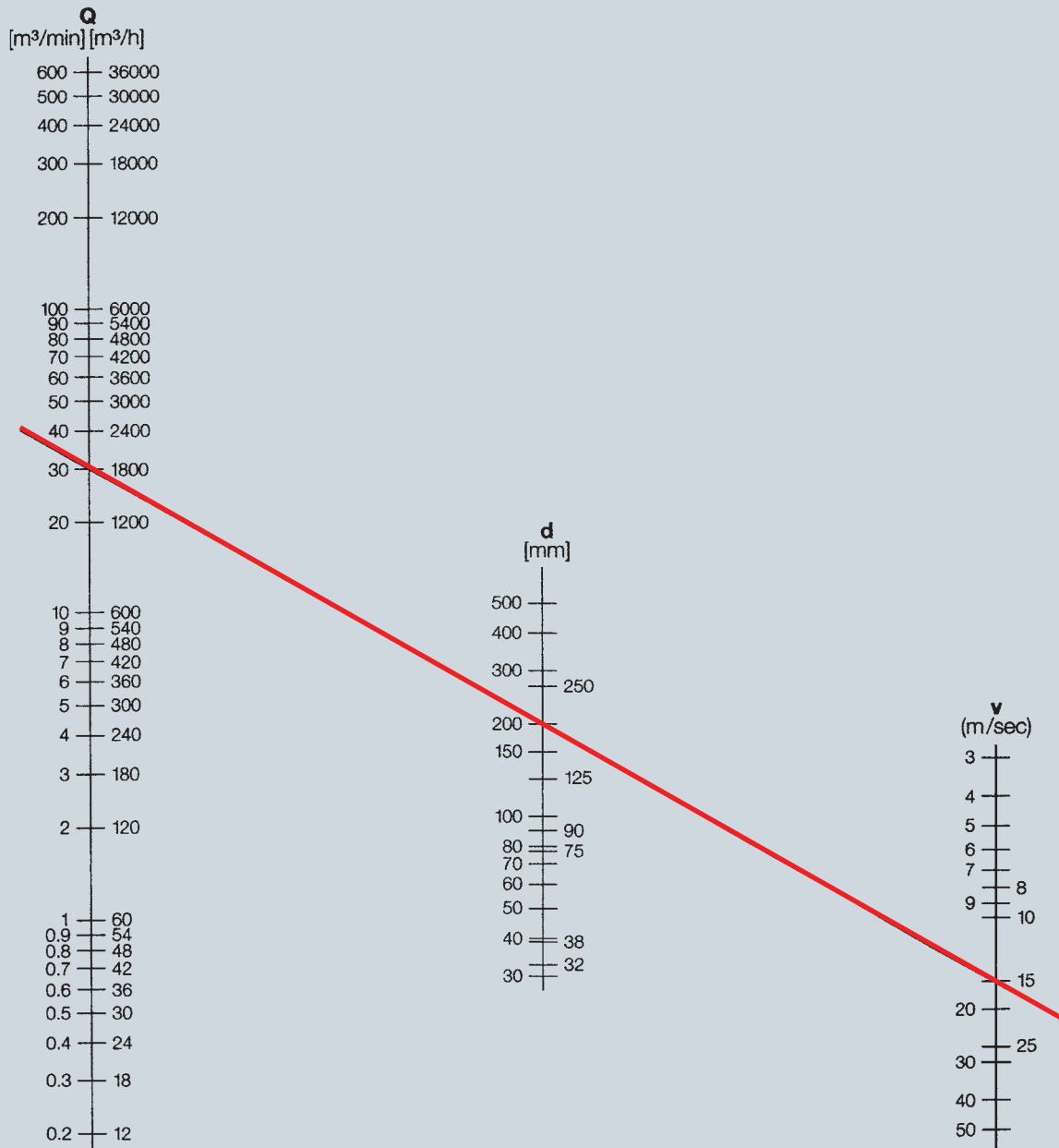

16.6 Material description Polyurethane (TPU)

16.6.1 Material description of Polyurethane (TPU)

The majority of the Masterflex suction and transport hoses for abrasive solids are made from high performance polyurethane.

Polyurethane is essentially created by the reaction of three components with each other:

1. Polyole (long-chain diols)
2. Diisocyanates
3. Short-chain diols

The type of raw materials, the reaction conditions and the proportions of the starting materials are responsible for the product characteristics. The applied polyols have a significant effect on specific properties of the thermoplastic polyurethane. Either polyester polyols or polyether polyols are used as polyols. Thermoplastic polyurethane elastomers, also known as TPU, have the quality and properties to meet the most varied requirements such as:

- Flexibility within a wide temperature range
- Great durability
- Kink/tear-resistant (high level of split and tear resistance)
- Good resilience and recoverability
- Good dynamic stability under load
- Hydrolysis and/or microbe resistance (for polyether types or for modified polyester-types)
- Good to very good resistance to atmospheric corrosion
- Resistance to oil, grease and solvents

16.6.2 Colour

The inherent colour is between yellowish and whitish opaque or also translucent, although the wall thickness is also a factor here. With increasing ageing of the material, the yellowish discoloration increases without adversely affecting the mechanical, thermal and chemical properties. Colouring is possible.

16.6.3 Mechanical properties

Resistance to further tearing

Resistance to further tearing means the resistance of a notched test object to further tearing. The test is carried out in accordance with DIN ISO 34-1. For hoses made of polyurethane, this means that even damaged hoses are less likely to tear further in comparison to other thermoplastic hoses (e.g. PVC, TPV, etc.).

Abrasion resistance

Abrasion in rubbers and elastomers is determined in accordance with DIN ISO 4649. Here, a test sample is forced with a certain pressure onto a rotating roller, which is covered with a test emery paper. The full friction length is approximately 40 m. The loss of mass due to abrasive wear is measured with due consideration of the thickness of the test sample and the abrasive power of the test emery sheet. This is indicated as a loss of volume in mm³. The standard PUR material applied has an abrasion level of approximately 25 - 30 mm³.

Comparative values of the raw materials used:

- | | |
|------------|----------------------------------|
| ● Rubber | approx. 60 - 150 mm ³ |
| ● Soft-PVC | approx. 100 mm ³ |
| ● TPV | approx. 200 mm ³ |
| ● PUR-EL | approx. 45 mm ³ |

For further data, see 17.9.

Field tests have produced even greater differences compared with the above materials, due to the increased dampening and rebound elasticity of the polyurethane material. The standardised test methods do not fully reveal these differences.

16.6 Polyurethane (TPU)

16.6.4 Thermal properties

Like all materials, TPU is subject to temperature dependent, reversible alterations in length. This is indicated by the coefficient of linear thermal expansion α [1/K] and calculated in accordance with DIN 53 752 in dependence of the temperature. Shore hardness is also an influencing factor. It is therefore advisable in many applications to take account of the temperature dependence when selecting PUR hoses. These hoses can be applied in temperatures up to +125 °C for short periods, but a temperature of +90 °C should not be exceeded for longer periods. Soft polyether-based types are flexible in temperatures down to -40 °C. Long-term tests of our processed materials have shown that even with a permanent temperature load in the limit range of +90 °C, only insignificant effects on the mechanical properties (heat ageing) occur.

16.6.5 Electrical properties

Surface resistance

The processed polyurethane material has a surface resistance of approx. 10^{10} Ohm and can therefore be used as electrically insulating protective hosing.

Dissipation of electrostatic charges

Please refer to chap. 17.10

16.6.6 Media resistance

The suitability of a plastic for a particular application often depends on its resistance to chemicals. The reaction of thermoplastic polyurethanes to the effects of chemical substances can vary greatly. The resistance of TPU to certain materials, e.g. cooling and lubricating agents, depends on the additives in these agents. The mechanical properties can change when in contact with such agents.

Swelling of the polyurethane material is often due to the effects of the media.

For the media resistance of TPU, please refer to the resistance list at the end of this catalogue.

Microbe resistance, see chapter 17.12.

16.6.7 Weathering resistance

The general resistance of TPU to ozone and ultra-violet radiation is good (for further details, please see chapter 16.12). The resistance of TPU to high-energy radiation such as α -, β -, γ -radiation is superior to that of most other plastics. The resistance to these kinds of radiation depends among other things on the dosage of the radiation, the form and dimensions of the product, as well as the climate and atmosphere in the location of the application. Certain properties, such as resistance to thermo-forming and chemicals, can be positively influenced by deliberate cross-linking as a result of high-energy irradiation with the aid of cross-linking agents.

16.6.8 Fire resistance

Plastics, like all organic materials, are combustible. The standard TPU we use is also inherently classifiable as such. The fire resistance of a material is not, however, a material property and it is influenced by different criteria. The complexity of the influencing factors makes it impossible to give a comprehensive and generally applicable description of the fire resistance of plastics, as the risk of combustion depends on factors such as the wall thickness, form, quantity and layout of combustible objects together with other circumstances of use.

For this reason, the fire resistance of plastics should not be described using words or phrases which may be misinterpreted, such as "self-extinguishing" or "non-flammable", but preferably by the relevant DIN standard. Hoses with flame-inhibiting additives are "hardly inflammable" acc. to DIN 4102 B1 and are - unlike most of our competitors' hoses - manufactured from highly abrasion-resistant polyester TPU (and not from polyether TPU).

16.6.9 Health assessment

The raw materials used to produce the PUR hoses comply with the statutory requirements for foodstuffs (see chapter 16.11).

16.7 Thermoplastic Vulcanisate

16.6.10 Hydrolysis resistance of PUR

The polyurethanes processed by Masterflex are permanently resistant to warm water up to max. +40 °C. At higher temperatures, polyester-polyurethane displays an increasing impairment of its mechanical material properties. Polyether-polyurethane, however, is permanently resistant to hydrolytic degradation.

16.6.11 Microbe resistance of PUR

As result of our consistent state-of-the-art product development, we have achieved a market first: not only does our polyester polyurethane now have a greater abrasion resistance, but is now also microbe-resistant thanks to the use of special additives. Microbes can quickly develop where there is extended contact with earth-like substances or deposits of grass, foliage, sludge etc.. Moisture combined with heat accelerates this process. The enzymes released by the microbes result - without appropriate treatment - in the splitting of the ester compounds and the embrittlement of the plastic until it falls apart. Polyether types are also resistant to microbial attack, but their resistance to abrasion is not as good - as described elsewhere.

16.7 Material Description

Thermoplastic Vulcanisate (TPV)

The hoses manufactured by Masterflex from the material TPV are produced from a thermoplastic rubber.

Thermo-plastic rubber belongs to a group of elastomers, which excellently combine the performance characteristics of vulcanisable rubbers, such as heat resistance and low compression set, with the easy processibility of thermo-plastics.

Thermo-plastic vulcanisate is a fully vulcanised polyolefin material. Production is carried out in a special dynamic vulcanisation procedure, which produces fully cross-linked rubber particles which in turn are distributed in a continuous matrix of thermo-plastic material.

The average rubber particle size of one micron or less results in extremely good physical material properties.

TPV has a resistance to environmental conditions corresponding to the standard EPDM rubber mixtures, whilst the chemical resistance is comparable to that of chloroprene rubber mixtures.

The performance characteristics of thermoplastic vulcanisates include:

- mechanical properties over a temperature range of -40 °C to +130 °C, peaks up to +150 °C
- resistance to chemicals in the chloroprene class for aqueous fluids, oils and hydrocarbons
- low compression set and tension set
- excellent hot air ageing behaviour at temperatures of up to +150 °C at periods of up to two weeks and up to +130 °C for longer periods
- excellent dynamic fatigue resistance
- outstanding resistance to ozone and weathering

The standard hoses are manufactured from black raw materials, but can also be coloured in accordance with customer requirements for appropriate delivery quantities.

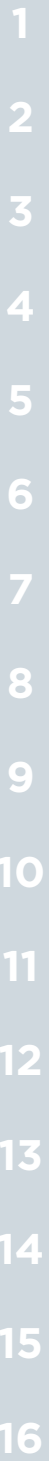

16.8 Soft PVC (Polyvinyl Chloride)

16.8 Material Description Soft PVC (Polyvinyl Chloride)

PVC is one of the amorphous plastics. Nevertheless, this material has excellent media resistance. For this reason PVC hoses are frequently used for applications with problematical media or environments. Only a number of solvents (aromatics, esters, ketones, chlorinated hydrocarbons) attack it.

PVC is a cost-effective, versatile material, which does, however, have the following disadvantages:

The temperature load capacity and the abrasion resistance of PVC are significantly inferior to that of PUR. Moreover, slow embrittlement of the material arises on flexible hoses as a result of plasticiser migration, which can lead to premature failure.

Note:

Highly toxic hydrochloric acid vapours and dioxins are formed from PVC in the event of fire. These can then constitute a significant health hazard, which may even be fatal, and can destroy electronic equipment through its corrosive effect.

16.9 Specifications of Applied Thermoplastic Raw Material

16.9 Specifications of Applied Thermoplastic Raw Materials

	Standard	Unit	Polyester PUR	Polyester PUR-AE (+ microbe protection)	Polyether PUR	Polyester PUR-EL (electroconductive)	Polyester PUR se	Thermoplastic Vulcanisate	Thermoplastic Vulcanisate hardly inflammable	Thermoplastic Vulcanisate abrasion resistant	Soft PVC
Abbreviation			TPU	TPU	TPU	TPU	TPU	TPV	TPV	TPV	PVC-P
Density	DIN EN ISO 1183-1	g/cm ³	1,20	1,20	1,19	1,19	1,20	0,98	1,12	0,95	1,22
Temp. Range permanent peaks to		°C °C °C	-40 to +90 +125	-40 to +90 +125	-40 to +90 +125	-40 to +90 +125	-40 to +90 +125	-40 to +130 +150	-40 to +130 +150	-40 to +110 +120	-20 to +70 +80
Hardness	DIN 53505	Shore A	78	78	80	84	78	73	80	80	74
Tensile Strength	DIN 53504	N/mm ²	45	45	53	19	45	8,5	8,7	15	16
Break Elongation	DIN 53504	%	650	650	530	500	650	420	520	700	350
Tear-growth Resistance	DIN-ISO 34-1	N/mm	60	60	90	65	60	24	33	25,5	43
Abrasion	DIN-ISO 4649	mm ³	25	25	30	54	25	200	158	49	92
Heat Ageing			++	++	++	++	++	+++	+++	++	---
UV-Resistance*			++	++	++	+++	++	+++	+++	+++	++
Weathering Resistance*			++	++	+++	++	++	++	++	++	++
Microbe Resistance			---	+++	+++	---	---	++	++	++	+++
Hydrolysis Resist.			+	+	+++	+	+	+++	+++	+++	+++
Temp. limit of h.s.		°C	<+40	<+40		<+40	<+40				
Inflammability							DIN 4102-B1		UL 94 V-0		

+++ = excellent

+ = limited suitability

* see chapter 16.6.7

++ = good

--- = not suitable

16.10 Dissipation of Electrostatic Charges on Masterflex Hoses

16.10 Dissipation of Electrostatic Charges on Masterflex Hoses

16.10.1 General

Hose lines can be a potential source of danger in pneumatic suction and conveying plants due to the build-up of electrostatic charges. The capacity to dissipate such charges is therefore mandatory in many areas of application to ensure safe operation. Hoses are used to transport solids (e.g. in the form of granular materials, chippings, dust, sand, cement, etc.) as well as liquids and gases. Electrostatic charges occur wherever solids, which are non-conductive have poor conductivity, come into contact with other materials and then separated again. As a result of this friction and the subsequent separation process, one material has fewer electrons than the other, which leads to one being positively and the other negatively charged. In the area of the common boundary surface, the so-called "interfacial potential" is formed, which enables the discharging of sparks. There are a number of ways to avoid such discharges and these are described in more detail below.

16.10.2 Regulations

A series of directives and regulations exist for evaluating and avoiding the risk of ignition as well as the appropriate safety precautions to be taken. At this point, we refer primarily to the German Technical Rule for Occupational Safety, TRGS 727 (ATEX) "Avoidance of ignition hazards due to electrostatic charges". TRGS 727 (ATEX) was prepared by the German Committee on Occupational Safety and published in the Joint Ministerial Gazette by the German Federal Ministry of Labour and Social Affairs.

The TRGS 727 replaces the former TRBS 2153 and updates it.

Masterflex products also fulfill the relevant regulation of harmonisation by the union: guideline 94/9/EG (until 19. April 2016) and guideline 2014/34/EU (from 20. April 2016)

16.10.3 Causes of electrostatic charges

During the transportation of solids, liquids or gases, the "interfacial potential" previously described is generated

by the friction on the inside of the hose. Depending on the degree of charge, this leads to sparks, electrical breakdown or in some cases the ignition of flammable materials. Aside from the intensity of the contact (friction) between the medium and the inner sides of the hose, the "dielectric permittivity" of the hose and medium is decisive for the extent to which charging is possible. This is considered to be a measure of the polarisability. Even conductive materials can become charged if not earthed.

16.10.4 Ways of avoiding electrostatic charges

The surface resistance of the hose wall materials can be reduced to values between 10^3 and 10^4 Ohm. These additives (e.g. conductive soot or "carbon black") form a network of conductive particles touching each other in the plastic (volume conductivity). Such plastics are, however, only available in black due to the colour of the additives.

Another possibility is the addition of anti-static agents to obtain a surface resistance of $<10^9$ Ohm and to maintain the transparent colour of the basic material. In certain anti-static agents, resistance is established by humidity absorption in the hose wall surface. This can be a disadvantage in some applications, e.g. the transport of dry powders, since the humidity absorbed from the air causes poor or insufficient anti-static properties. Furthermore, the application-specific abrasion may impair the establishment of the required surface resistance. This is why anti-static hoses should be used in the appropriate zones/applications. Ideally, these should be equipped with permanent anti-static additives, which are not dependent on any additional external aspects.

For secondary applications, such as "gases and liquids of low conductivity" in Zone 1 and "non-combustible dusts/bulk goods" in Zone 21, spiral/clip hoses can be applied, if their wall material specifically offers a surface resistance of $> 10^9$ Ohm. Here, it is important to note that the helix/clip interval must be < 30 mm and the helix overlap must be < 2 mm.

All of the applications mentioned above require both helix/clip ends to be earthed to the connector to ensure static dissipation. For further information on the possible applications of Masterflex hoses, please refer to the specific product data sheets.

16.10.5 Limit determination & definition

In general, the following can become electrostatically charged:

16.10 Dissipation of Electrostatic Charges on Masterflex Hoses

- Hoses with a wire spiral
- Solids with a surface resistance of $>10^9$ Ohm
- All non-earthed objects made from electro-conductive materials

In general, the following are not capable of becoming electrostatically charged:

- All solids and liquids, which fall short of the above critical resistance values
- All conductive materials which are earthed.

In practice, when using hose lines with a wire helix/clip, this means the following:

1. Wire-reinforced hoses / clip hoses may be used for “gases and liquids of low conductivity” in Zone 1 and “non-combustible dusts/bulk goods” in Zone 21 if their wall surface resistance is $> 10^9$ Ohm, the helix/clip interval is < 30 mm and the overlap of the helix/clip is < 2 mm. For the mounting and installation of the hoses, it is important to ensure that both helix/clip ends have an earthed connection.
2. Increased protection can be obtained by using non-chargeable hoses, such as anti-static hoses with a surface resistance of $< 10^9$ Ohm. Again, the exposed helix/clip ends must have an earthed connection.
3. Electroconductive hoses with a surface resistance of $< 10^6$ Ohm offer optimum safety. However, even these hoses require an earthed connection between the exposed ends of the wire and the electroconductive connection socket for safety reasons. Tested Masterflex hoses with the addition “EL” comply fully with these requirements and are electroconductive to $< 10^4$ Ohm.

16.10.6 Measurement method

The determination of the surface resistance depends on the relevant measurement method and is determined for non-conductive solids in accordance with DIN IEC 60093 / VDE 0303, Section 30 (Test method for electrically insulating materials, flow resistance and specific surface resistance of solid, electrically insulating materials). For rubber/plastic hoses and hose lines, the standard DIN EN ISO 8031 - “Rubber and plastic hoses and hose lines” describes the determination of the electrical resistance.

This standard describes:

- Procedures for hoses with conductive inner layers (e.g. the method of measuring Masterflex hose types Master-Clip ...)
- Procedures for hoses with a conductive outer layer
- Procedures for hoses made from a mixture of materials, which are conductive throughout (e.g. the measurement method for the profile-extruded Masterflex hose types with “EL”).

16.10.7 Note

The addition of conductive additives or anti-static agents reduces the mechanical properties of the material (e.g. resistance to abrasion and tearing) and thus reduces service life. The information summarised under points 1 to 6 is based on internal and external field research and on the currently applicable regulations. It serves as a guideline for using Masterflex hose types in areas of potential danger but no guarantee is given for its entirety.

The catalogue details relating to surface resistance are based on official test results, details supplied by our raw material suppliers and internal measurements. In case of doubt, we recommend that users test the hoses under operating conditions or similar circumstances before final installation.

16.11 Food Law Requirements & Certifications

16.11 Food Law Requirements & Certifications

In order for hoses to be authorized for use within the food industry, they must adhere to and fulfil the appropriate "food law regulations". Masterflex produces hose systems made from polyurethane and hoses made from polyolefin, which fulfil all requirements:

16.11.1 Polyurethane hoses:

Hose Types:

Master-PUR Flat L Food, Master-PUR Flat H Food, Master-PUR Flat SH Food, Master-PUR L-F Food, Master-PUR L Food, Master-PUR H Food, Master-PUR HX Food, Polderflex PUR Food

or all hoses, which are made from the same material as the hoses listed above with a wall thickness of < 5.5 mm and an inner diameter of < 20 mm.

The raw materials used to produce Master-PUR Food hoses comply with the following statutory requirements for foodstuffs:

EU

The Master-PUR Food range has been tested and certified by an independent institute.

The hoses included in the Master-PUR Food range fulfil and are in accordance under certain conditions with the requirements of the regulation (EU) No. 1935/2004, as well as the regulation (EU) No. 10/2011 and 1282/2011, the German Food and Feed Code (LFGB, from 15th March 2012) and the Consumer Goods Ordinance (from 13th Dec. 2011).

For further information on the conditions, please refer to the test certificate H-224987-12-Bg.

The raw materials applied are also listed in Chapter 2 of the recommendation "XXXIX. Consumer Goods based on Polyurethanes" (from 1st Jan. 2012).

USA

The raw materials and additives used (excluding stabilisers) are listed in 21 CFR (Code of Federal Regulations) § 177.2600 "Rubber articles intended for repeated use" of the FDA dated 01.04.2009. The antioxidants/stabilisers used are listed in FDA 21 CFR § 178.2010 "Antioxidants and/or stabilizers for polymers".

16.11.2 Hoses made from antistatic polyurethane

Hose Types:

Master-PUR L-F Food A, Master-PUR L Food A, Master-PUR H Food A, Master-PUR HX Food A, Master-PUR HX-S Food A, Polderflex PUR Food A

or all hoses, which are made from the same material as the hoses listed above with a wall thickness of > 0.4 mm and an inner diameter of > 20 mm.

The raw materials used to produce Master-PUR Food A hoses comply with the following statutory requirements for foodstuffs:

EU

The Master-PUR Food A range has been tested and certified by an independent institute.

The monomers used in the production of the raw materials are listed in the commodities' regulation as disclosed on 23.12.1997 (Official Federal Gazette 1998 1 S.5), amended on 23.09.2009 (Official Federal Gazette IS 3130).

The monomers used are listed in the annexes to EC Directive 2002/72/EC as amended in the amending directive 2007/19/EC dated 30.03.2007 and 2008/39/EC dated 07.03.2008 as well as the EC directive 975/2009 dated 20.10.2009.

The additives used (excluding catalysts) are listed in annex III of EC Directive 2002/72/EC, amended by directive 2007/19/EC and 2008/39/EC as well as the EC directive 975/2009 dated 20.10.2009. For further information on the conditions, please refer to the test certificate H-192339K-10-Bg. The certificate will be shown on request of the user.

16.11 Food Law Requirements & Certifications

USA

The applied additives (excluding stabilisers) are listed in 21 CFR (Code of Federal Regulations) § 177.2600 and 21 CFR § 178.2010 "Rubber articles intended for repeated use" of the FDA dated 01.04.2009, as well as in the Effective Food Contact Substance Notifications (FCS).

16.11.2.1 TRGS 727

Technical Regulations for Operating Safety (ATEX/TRGS) 727 "Avoidance of Ignition Hazards from Electrostatic Charges". For further details, please refer to section 16.10.

16.11.3 Connection elements

The raw materials used to produce Master-GS Food connecting elements comply with the following statutory requirements for foodstuffs:

EU

The monomers used in the production of the raw materials are listed in the commodities' regulation as disclosed on 23.12.1997 (Official Federal Gazette 1998 I S.5), last amended on 23.03.2009 (Official Federal Gazette IS 3130) as well as the EC directive 975/2009 dated 20.10.2009. The starting materials applied are also listed under No 2.1, category 1, of recommendation XXXIX, "Commodities based on polyurethane" of the Federal Institute for Risk Assessment. The monomers used are listed in the annexes to EC Directive 2002/72/EC as amended in the latest amending directive 2004/19/EC dated 01.03.2004.

The additives used (excluding catalysts) are listed in annex III of the EC directive 2002/72/EC, last amended by the directive 2004/19/EC, in appendix 3a of the Commodities Directive, listed in the Synoptic Document No. 7 (with a classification of 0 - 3 in the SCF lists). Catalysts are not regulated by the EC directives.

The connecting system Master GS-70D Food has been tested and approved by an independent institute. For the conditions of the requirements listed in the regulations, please refer to the certificate. The certificate will be presented upon request by the user.

Notes:

Product Selection

It is the responsibility of the user to check whether the selected hose type is suitable for the application in contact with foodstuffs.

BFR, Regulations, Directives

The hoses supplied by Masterflex correspond to the regulation (EC) 1935/2004 from 27th Oct. 2004, the BfR recommendations for the applied materials and, depending on the product, the directive 2002/72/EC or the regulation (EU) No. 10/2011 for plastics.

Note on new Regulation (EU) No. 10/2011:

All current certifications acc. to regulation 2002/72/EC are valid until 13th Jan. 2016, as listed in section 46 (page 7) of the regulation (EU) No. 10/2011.

GMP

The hoses produced by Masterflex are manufactured according to the regulation 2023/2006 dated 22nd Dec. 2006 (GMP = "Good Manufacturing Practice").

Other Notes

Please note that disinfectant containing active chlorine, independent of the contact conditions and the frequency of the contact, can damage our products. We advise against sterilisation via steam. This may damage the product material.

16.12 Terminology & Definitions

16.12 Terminology & Definitions

Abrasion

Undesirable alteration of the surface due to the detachment of small particles as a result of mechanical strain. This erosion process is generally referred to as wear in plastics (and many other materials). (Also see section 16.6 Material Description Polyurethane).

Additives

All constituents in synthetic mixtures which are not polymers or their primary products or which are only added in relatively low quantities (e.g. conductive carbon black, flame retardants, UV stabilising agents, etc.).

Ageing

The entirety of all irreversible chemical and physical processes occurring in a material over the course of time. This usually leads to a deterioration in performance characteristics. Often caused by: heat, light, high-energy radiation, chemicals, weather, oxygen (ozone), plasticiser migration in PVC, etc.

Bend Radius

The bend radius is given in mm. All figures refer to the inside of the hose bend at maximum operating pressure.

Elasticity

The ability of a material to reverse alterations in shape or volume caused by outside forces or moments.

Elastomers

Designation for loosely cross-linked, macro-molecular materials which can be extended to at least double their original length under the influence of a small force at ambient temperature and above and can resume their original shape quickly and practically completely once the deforming force has been removed.

Flame Retardants

These are synthetic additives which reduce the flammability of plastics.

Flexibility

Expenditure of energy necessary to attain the minimum bend radius (the greater the expenditure of force, the lower the flexibility).

Gas Permeability

See Permeation

Halogens

The elements fluorine (F), chlorine (Cl), bromine (Br) and iodine (I) form the group of halogens.

Hardness

The resistance of one body to the penetration of another. In rubber-type materials the Shore hardness is determined in accordance with DIN 53 505. A needle (truncated taper for Shore A and conical for Shore D) is pressed into the sample with a certain spring tension. The hardness is measured by the depth of penetration (scale range 0 to 100 in Shore).

Hydrolysis Resistance

Hydrolysis = irreversible splitting of the polyester chains in polyester polyurethanes. It occurs after a long period in hot water, saturated steam or a tropical climate (moisture combined with heat). The result of hydrolysis is a decrease in mechanical strength properties. Hardly any hydrolytic decomposition is observed in polyester polyurethanes at ambient temperature.

Lining

Application of a surface layer with particular properties onto foil/film or plates as well as the application of foil/film or onto fabric sheeting.

Microbe Resistance

Polyester-based thermoplastic polyurethanes without additional protection against microbes are at risk of decomposition caused by microbial attack. Moisture combined with heat (e.g. in nutritive environments such as grass, foliage, agriculture, etc.) can accelerate this process. In such surroundings the micro-organisms multiply very rapidly. The enzymes they release split ester compounds and destroy the synthetic part. Localised attack is evident initially, in contrast to hydrolytic decomposition which occurs over the entire surface. Polyether-based polyurethanes are to a large extent resistant to decomposition by microbial attack but their mechanical properties are not as good as those of comparable polyester polyurethanes.

Permeation

Passage of a gas through a test sample. This occurs in three stages:

16.12 Terminology & Definitions

1. Dissolution of the gas in the test body.
2. Diffusion of the dissolved gas through the test sample.
3. Evaporation of the gas from the test body.

The permeation coefficient is a material constant, which indicates the volume of gas which passes through a test sample of known surface and thickness at a given partial pressure difference in a particular time. It depends on the temperature and is calculated in accordance with DIN 53 536.

Swelling

Absorption of liquid or gaseous matter in solids without a chemical reaction occurring between them. The results are an increase in volume and weight accompanied by a corresponding decrease in mechanical properties. Once the absorbed matter has been exhausted and swelling has decreased accordingly, the original properties of the product are almost completely restored. Swelling is therefore a reversible process.

Peak Pressure Resistance

Resistance to the collapsing of suction and pressure hoses through outer peak loads.

Tear-Growth Resistance

Resistance of a notched test sample to further tearing. The test is carried out in accordance with DIN 53 515 on corner samples with a cut in one side.

UV Radiation

Plastics can be chemically broken down by the effects of UV radiation depending on the duration and intensity (ageing). The resistance of polyurethanes to UV radiation is good in general, but over the course of time the material turns yellow and the surface becomes slightly brittle. This results in a slight reduction in the mechanical properties. Stabilisation against ageing can be attained by using UV stabilisers and/or through colour pigmentation.

Ozone Resistance

Ozone is the combination of three oxygen atoms into one molecule (O₃). It is formed by the action of high-energy UV radiation on the oxygen in the atmosphere. Due to its composition, ozone is very reactive and reacts easily with organic substances. The resistance of polyurethanes to ozone is good in general.

Temperature Range

Definition of the range, in which the temperature of the transport medium can be found. The term "peaks to ... °C", depending on the material, refers to a temperature impulse of 10-20 seconds, where no significant damage can occur to the product.

16.13 Material & Testing Standards

The following section lists the most important material testing standards from the standards DIN and EN:

16.13.1 Pressure & Vacuum

DIN EN ISO 1402 (PRESSURE)

Rubber and plastic hoses and hose lines - hydrostatic tests

16.13.2 Electroconductivity

DIN EN ISO 8031

Rubber and plastic hoses and hose lines

- Determination of electrical resistance and the electroconductivity DIN IEC 60093
- Test method for electrically insulating materials, volume resistivity and specific surface resistance of solid, electrically insulating materials DIN VDE 0303-8
- VDE requirements for the electrical testing of insulating materials, evaluation of electrostatic behaviour

DIN 54345-1

Testing of Textiles

- Electrostatic behaviour, determination of electrical resistance variables

16.13.3 Flammability

DIN 4102-1

- Fire resistance of building materials and components

DIN EN ISO 6941

Textiles, Burn Behaviour

- Determination of burning behaviour, perpendicular method, burning due to ignition at the lower edge

16.13 Material & Testing Standards

DIN 66083

- Characteristic values for the burning behaviour of textile products, textile fabric for working and protective clothing

16.13.4 Mechanical Tests

DIN ISO 4649

- Elastomers or thermoplastic elastomers
 - Requirements of abrasion resistance using a device with rotating cylinder drums

DIN 26057

Requirements on spiral hoses made of TPU

DIN 53752

Testing of Plastics

- Requirements of linear thermal expansion coefficients

DIN 53505

Testing of Rubber & Elastomers

- Hardness testing acc. to Shore A and D

DIN 53359

Testing of imitation leather and similar fabrics

- Permanent buckling test

DIN 53863-2

Testing of Textiles

- Abrasion test of textile fabrics, rotary abrasion test (Schopper-Test)

DIN ISO 34-1

Elastomers or Thermoplastic Elastomers

- Tear growth test - Part 1: strip/angle/bend-shaped test objects

DIN 53504

Testing of Rubber & Elastomers

- Requirements of tear resistance, tensile strength, elongation of break and tensile values in tensile test

DIN EN ISO 1183-1

Plastics

- Procedure for determination of density of non-foam plastics - Part 1: dip method, procedure with liquid pycnometer and titration

16.13.5 Ambient Influences

DIN EN ISO 4892

Plastics

- Artificial weathering or radiation in devices
 - Part 1: General instructions

16.14 Conversion Table

16.14 Conversion Tables

16.14.1 Powers of Ten (10)

G Giga-	=	10 ⁹	=	1 000 000 000	Thousand Million
M Mega-	=	10 ⁶	=	1 000 000	Million (M.)
k Kilo-	=	10 ³	=	1 000	Thousand (K)
h Hecto-	=	10 ²	=	100	Hundred
da Deca-	=	10 ¹	=	10	Ten
	=	10 ⁰	=	1	One
d Deci-	=	10 ⁻¹	=	0.1	Tenth
c Centi-	=	10 ⁻²	=	0.01	Hundredth
m Milli-	=	10 ⁻³	=	0.001	Thousandth
μ Micro-	=	10 ⁻⁶	=	0.000 001	One Millionth
n Nano-	=	10 ⁻⁹	=	0.000 000 001	One Thousand Millionth

16.14.2

Conversion of Pressure Units (p)

	Pa	bar	mm WG	PSI	kp/cm ²
1 Pa =	1 N/m ²	0.00001 10 ⁻⁵	0.102	0.00015	0.0000102 1.62 • 10 ⁻⁵
1 bar	100000 10 ⁵	1	10200 1.02 • 10 ⁴	14.514	1.02
1 mm Ws	9.807	0,00009807 9.81 • 10 ⁻⁵	1	0.00142	0.0001
1 PSI	6.895	0.0689	703.2	1	0.07028
1 kp/cm ²	98.100 9.81 • 10 ⁴	0.981	10.000	14.22	1

16.14.3

Temperature

$$\text{Celsius: } \quad \text{°Celsius} = \frac{5}{9} (\text{°Fahrenheit} - 32) \times \frac{9}{5}$$

$$\text{Fahrenheit: } \text{°Fahrenheit} = \quad \times \text{°Celsius} + 32$$

16.14 Conversion Tables

16.14.4 Conversion of Units of Length

	m	cm	mm	µm	in	ft	yd
1 m	1	100	1000	1,000,000	39.37	3.28	1.094
1 cm	0.01	1	10	10,000	0.3937	0.0328	0.01094
1 mm	0.001	0.1	1	1000	0.03937	0.00328	0.001094
1 µm	0.000001	0.0001	0.001	1	$3,937 \times 10^{-6}$	3.28×10^{-6}	1.094×10^{-6}
1 in = 1 inch	0.0254	2.54	25.4	25,400	1	0.083	0.0278
1 ft = 1 foot	0.3048	30.48	304.8	304,800	12	1	0.333
1 yd = 1 yard	0.9144	91.44	914.4	914,00	36	3	1

16.14.5 Conversion of Volume Flow Rates

	l/s	l/min	l/h
1 m ³ /s	1000	60,000	3.6×10^6
1 m ³ /min	16.67	1000	60,000
1 m ³ /h	0.278	16.67	1000

16.14.6 Conversion of Weights

	Pounds	Kilograms	Ounces	Grams
1 Pfund	1	0.4536	16.282	453.6
1 Kilogramm	2.205	1	35.3	1000
1 Unze	0.062	0.0284	1	28.35
1 Gramm	0.0022	0.0001	0.0353	1

16.15 CE Accreditation of Masterflex Products

The CE accreditation (Conformité Européenne) stands for “compliance with EU directives” and is a EU product safety marking for certain products. By affixing the CE mark, manufacturers attest the conformity with one or several EU directives applicable to the respective product. This marking has meanwhile become mandatory for certain product groups. There are no trade restrictions for CE marked products within the EU member states whereas products without the CE mark, which are subject to marking, may not be placed on the market from a specific date onwards (e.g. machinery requires marking since 1st January 1995).

Masterflex hoses are not included in those product groups subject to mandatory marking. This is due to the fact that, as per EC Machinery Directive 89/392/EEC, hoses are neither considered machinery, safety components nor products regulated under the low-voltage or EMC directives, medical products directive etc. Hoses are components that may not bear the CE mark.

As a consequence, the CE mark may not be affixed to hoses and the Masterflex SE is not allowed to issue declarations of conformity (manufacturer’s declarations).

If requested, it is possible though to provide data safety sheets acc. to DIN EN 292 and works certificates acc. to EN 10204 that attest the characteristics of Masterflex products. Masterflex SE is certified in accordance with DIN EN ISO 9001. We assure the high quality of our products.

The data provided by Masterflex is considered general information. Since individual applications, local conditions and hose designs differ, no liability or guarantee can be derived from the given information.

- 1
- 2
- 3
- 4
- 5
- 6
- 7
- 8
- 9
- 10
- 11
- 12
- 13
- 14
- 15
- 16

Chemical Resistance

1 = excellent resistance

3 = medium resistance

2 = good resistance

x = non-resistant

	PUR-Ester	PUR-Ether	Silicone	Hypalon*	Viton*	PVC	PE	PTFE	Neoprene*	Kapton*	TPV	PE-EL
accumulator acid (sulphuric acid 30%)	x	2	x	1	1	1	1	1	2	1	1	
acetaldehyde	3	2	2	3	2	x	2 to 3	1	3	1	1	1
acetamide	x	x	2	2	1 to 2	x	1	1	1		1	1
acetic acid 10%	3	2	2	1	2	3	1	1	1	1	1	1
acetic acid 100% (conc.)	x	x	2 to 3	3	x	x	x	1	x	1	1	1
acetic acid 25%	x	3	2 to 3	1 to 2	2	x	1	1	1 to 2	1	1	1
acetic acid 3%	2	1	1	1	2	1	1	1	1	1	1	1
acetic acid 50%	x	x	2 to 3	2	2	x	3	1	2 to 3	1	1	1
acetic acid anhydride 50%	x	x	1	1	x	x	3	1	2	1	1	
acetic acid ethyl ester (ethyl acetate)	x	x	2	x	x	x	2	1	3	1	1	1
acetone	3	x	2	2 to 3	x	3	1 to 2	1	3	1	1	1
acetyl salicylic acid (aspirin)					1	1	1					1
acetylacetone	3	x	x		x	x	x	1		1	1	x
acetylene gas	2-3	2-3	2	2	1	1	3	1	2	1	1	1
acids see spec. designation, applicable in general	x	3	2	2-3	1-2	1-2	2	1	3	1	1-2	
acrylic acid ethyl ester (ethyl acrylate)	x	x	2	1	x	x	x	1	x	1	1	x
acrylonitrile	x	x	2	3	2	x	1	1	3	1	1	1
adipic acid (hexane diacid)	3	1 to 3	x	1	1	1	1	1	2	1		
adipic acid diethyl ester				1	x	x		1		1	1	
adipose (animal grease)	1	1	3	1 to 2	1	2	2 to 3	1	3	1	2	1
air, atmospheric, oil-free, to +°C	85	80	175	120	200	70	90	200		200	125	1
air, oil-saturated, to +°C	85	80	175	120	200	70	90	200		200	125	1
alcohols see specific designations, applicable in general	2-3	2-3	1-2	1-2	1-2	1-2	1-2	1	2	1	2	1
aliphatics see gasoline low aromatic												
applicable in general	1-2	2	3-x	3	1	2-3	3-x	1	3	1	2-x	1
aldehyde see specific designations, applicable in general	3	3	2-3	2-3	2-x	3	1-2	1	3	1	2	
allyl alcohol (propenol)	3	3	x	1 to 3	3	3	1	1			1	1
allyl chloride (3-chloropropene)	x	x	1		x	x	x	1		1		x
alum (potassium aluminium sulphate)	2	1	1 to 2	1	1	1	1	1	2	3	1	1
aluminium acetate, aqu. (basic aluminium acetate)	x	3	x	1	x	1	1	1	1	1	1	1
aluminium chloride, aqu.	3	1 to 2	2	1 to 2	1	1	1 to 2	1	1	1	1	1
aluminium fluoride	3	3	2	1	1	1	1	1	1	1	1	1
aluminium hydroxide	3	2	1	1	1	1	1	1	1	1	1	1
aluminium nitrate, aqu.	3	2	2	1	1	2	1	1	1	1	1	1
aluminium phosphate, aqu.	2	1	1	1	1	1	1	1	1	1	1	1
aluminium sulphate, aqu.	3	2	1	1	1	1	1	1	1	1	1	1
amines see specific designations, applicable in general	x	x	3	3	2-3	x	2-3	1	2-x	1	2	
amino acetic acid (glycine)	x	x	2 to 3	2 to 3	1	1		1			1	
ammonia nitrate, aqu.	3	2	1	3	3	2	1	1	2	1	1	1
ammonia, aqu. 25% (ammonia water)	x	x	1	3	1	1	1	1	2	x	1	1
ammonia, gaseous 20°C	x	3	1	2	1	1	1	1	1	1	1	1
ammonia, liquid 100%	x	x	3	2	x	3	2	1	1	1	1	1
ammonium acetate, aqu.	x	x	3-x	1	x	1	2	1			1	1
ammonium carbonate, aqu.	x	x	2 to 3	1	1	1	1	1	1	1	1	1
ammonium chloride, aqu. 3%	3	1	1	2	1	1	1	1	1	1	1	1
ammonium diphosphate, aqu.	3	1	1 to 2	1	1	1	1	1	1	1	1	1
ammonium fluoride, aqu.	x	x		1	1 to 2	1 to 3	1	1			1	1
ammonium hydroxide, aqu. (ammonia, aqu.)	x	x	1	3	1	1	1	1	2	x	1	
ammonium metaphosphate	2	1	1	1	1	1	1	1	1	1	1	2
ammonium nitrate	1	1	2	1	1	2		1	1	1	1	1
ammonium persulphate, aqu.	3	2	2 to 3	2	1	1	1	1	2	1	1	
ammonium phosphate, aqu.	3	1	1	2	1	2	1	1	1	1	1	2
ammonium sulphate	2	1	1	1	1	1	1	1	1	1	1	1
ammonium thiocyanate	3	2	1		1	1	1	1		1	1	1
ammonium-urea-solution (liquid nitrogen fertiliser)	x	x				2	2	1				

*) at +20 °C ambient temperature

*1) as foodstuff, please order food-grade quality versions

*2) please ask for our detailed consultation

* registered trademark of El du Pont des Nemours and Company or one of its subsidiaries

	PUR-Ester	PUR-Ether	Silicone	Hypalon*	Viton*	PVC	PE	PTFE	Neoprene*	Kapton*	TPV	PE-EL
amyl acetate* ¹ (acetic acid pentyl ester, banana oil)	x	x	3	x	x	x	2	1	3	1	1	1
amyl alcohols (pentanols)	3	3	3	1	2	1	1 to 2	1	1	1	1	1
amyl borate	x	x	x	1	1			1	1	1	1	
amyl chloride	x	x	3	x	2	x	x	1	x	1	2	x
aniline (aminobenzene)	x	x	2	3	1 to 2	2 to 3	2 to 3	1	x	1	1	2
aniline dyes	x	x	2 to 3	2 to 3	1	1	3	1	2	1	1	
aniline hydrochloride	x	x	x	x	x	x	2 to 3	1	x			1
animal fats (oils and greases, adipose)	1	1	3	1 to 2	1	2	2 to 3	1	3	1	2	1
anise seed oil						x	3-x	1	x			1
anol (cyclohexanol)	3	x	2 to 3	1 to 2	1	x	1	1	2	1	2	1
anone (cyclohexanone)	3	x	x	x	x	x	2 to 3	1	x	1	2 to 3	1
anthraquinone sulfonic acid, aqu.	x	x	x	1	1	1	1	1			1	1
antichlorine (sodium thiosulphate)	3	2	1	1	1	1	1	1	1	1	1	
antifreeze see precise chem. designation												
antimony chloride 50%	3	2	x	1	1	1	1	1	1	1	1	1
antimony chloride, anhydrous	x	x	3	1	1 to 2	1	1	1			1	1
apple acid, aqu. * ¹ (apple juice)	x	3	1	1	1	1	1	1	1	1	1	1
aqua fortis (nitric acid 50%)	x	x	x	3	1 to 2	2 to 3	2 to 3	1	x	1	1 to 2	
aqua regia (nitrohydrochloric acid)	x	x	3	3	2	2 bis 3	2	1	3	1	3	
arctones = ICI freontypes	ask for our detailed advice											
argon gas	1	1	1	1	1	1	1	1	1	1	1	1
aromatics see benzene, toluene, xylene												1
homologues, applicable in general	3-x	3-x	x	3-x	1-2	x	x	1	3	1	3-x	
arsenic acid	3-x	3-x	1	1	1	1	1	1	1	1	1	1
ascorbic acid (vitamin C)	2-3	1			1	1	1					
asphalt (pitch)	2	2	2	2	1	2	1	1	2	1	2 to 3	1
ASTM fuel A (isooctane, free of aromatics)	1	1	x	1	1	3-x		1	1		x	
ASTM fuel B	x	x	x	x	1	3-x		1	x		x	
ASTM fuel C	x	x	x	x	1	3-x		1	x		x	
ATS-brake fluid	x	x	3	1	1	1	1	1			2 to 3	1
avgas, aviation gasoline (kerosene)	1	1-2	x	2	1	3	2	1	2	1	x	1
bacon fat * ¹	1	1	2	3	1		1	1	x	1	1	
baking soda (sodium bicarbonate, aqu.)	x	2	1	1	1	1	1	1	1	2	1	
barium chloride, aqu.	2	1	1	1	1	1	1	1	1	1	1	1
barium hydroxide	3-x	2	1	1	1	1	1	1	1	1	1	1
barium sulphate (barite)	1	1	1	1	1	1 to 2	1	1	1	1	1	1
barium sulphide	2	2	1	1	1	1	1 to 2	1	1	1	1	1
barm (yeast), aqu.	x	1	1	1	1	1	1	1			1	1
bases (lyes) see exact designation, applicable in general	x	2	2	1	2	1	1 to 2	1	1 to 2	1	1 to 2	
beer * ¹	2	1	1	1	1	1	1	1	1	1	1	1
benzaldehyde (oil of bitter almonds, benzoic aldehyde)	3	3	2 to 3	x	2 to 3	3	2	1	x	1	2	1
benzene see also gasoline	x	x	x	3-x	2-3	3-x	3-x	1	x	1	x	1
benzoic acid, aqu.	x	x	3-x	x	1	1	1	1	x	1	1	1
benzyl alcohol	x	x	1	2 to 3	1	3	3	1	3	1	2	1
benzyl benzoate	x	x	1	1	1			1	x	1	2	
benzyl chloride	x	x	2	x	1	x	2 to 3	1	x	1	x	2
bicarb, bicarbonate of soda (sodium bicarbonate)	x	2	1	1	1	1	1	1	1	2	1	
bio-gas clean	2	3	3-x	2-3	1	2	1	1	2-3	1		
bio-gas (marsh-gas)	ask for detailed advice and give exact chem. designation											
biphenyl (diphenyl)	x	x	x	3	1	x	2	1	x	1	3	2
biphenyls, polychlorinated (pyranols, transformer oils)	2	2	x	x	1	3	3	1	2-3	1	x	3
bis (2-hydroxyethyl) ether	3	3	2	2	1	3	1-2	1	1	1	1	
bismuth carbonate	1	1	1		1	1	1	1	1	1	1	1
bisulphite lye containing SO ₂					1	1	1	1	1	1	1	1

*) at +20 °C ambient temperature

*¹⁾ as foodstuff, please order food-grade quality versions

*²⁾ please ask for our detailed consultation

* registered trademark of El du Pont des Nemours and Company or one of its subsidiaries

1
2
3
4
5
6
7
8
9
10
11
12
13
14
15
16

Chemical Resistance

1 = excellent resistance

3 = medium resistance

2 = good resistance

x = non-resistant

	PUR-Ester	PUR-Ether	Silicone	Hypalon*	Viton*	PVC	PE	PTFE	Neoprene*	Kapton*	TPV	PE-EL
bitter-salt (magnesium sulphate)	1	1	1	1	1	1	1	1	1	1	1	1
bitumen 20°C (see also hot bitumen)	2	2	3	3	1	x	1	1	x	1	2 to 3	1
black lye (cellulose extraction)	x	x	x	1	1			1				
blanc-fixe (barium sulphate)	1	1	1	1	1	1	1	1	1	1	1	1
bleaching lye (javelle-lye, potassium hypochlorite)	3	2	2	2 to 3	1	1	3	1	2 to 3	3	1 to 2	3
blood						1	1	1				1
bone oil	1	1	2 to 3	x	1	2		1	x		x	
borax (sodium borate)	1	1	2	2	1	1	1	1	1	2	1	1
boric acid, aqu.	3	1	1	1	1	1	1	1	x	1	1	1
brake fluid, ATS-	x	x	3	1	1	1	1	1			2 to 3	1
brake fluid, glycol-ether-based	x	x								1	1	
brandy, all kinds*1	2	1	1	1	1	1	1	1	1	1	1	1
brine (table or common salt solution)*1	3	1	1	1	1	1	1	1	1	1	1	1
bromine	x	x	x	x	1	3	x	1	x	1	3	x
bromine water	x	x	x	2 to 3	1	x	x	1	x	1	3	x
bromobenzene	x	x	x	x	1	x	x	1	x	1	x	1
butadiene	2	1 to 2	x	2	2	3	2 to 3	1	2	1	2	2
butan diols (butylene glycols)	1	1		1	2	3	1	1			1 to 2	1
butane diacid	x	3	3	1	1	1	1	1			1	
butane gas	1	1	3-x	2	1	2	3-x	1	2	1	2	3
butane, liquid	1	1	3	1	1	2	1	1	1	1	2	1
butanol (butyl alcohol)	3	3	2	1	2 to 3	1	1 to 2	1	1	1	1	1
butanone (methyl ethyl ketone MEK)	x	x	x	x	x	x	2	1	3	1	1	1
butine diol	1	1		2	3			1				
butter milk*1	1	1	1	1	1	1	1	1	2 to 3	1	1	1
butter*1	1	2	2	2	1	2	1	1	2	1	2	1
butyl acetate (acetic acid butyl ester)	x	x	3	3	x	x	3-x	1	x	1	2	1
butyl benzoate	1	1	x	x	1			1	x	1	2	
butyl carbitol	x	x	2 to 3	2	1			1	3	1	2	
butyl ether	x	3	3		x	1	1	1	2 to 3	1	2	
butyl glycol	3	3	2		1	x	1	1	x	1	2	1
butyl oleate	x	x	1	x	1			1	x	1	2	
butyl phenols	x	x		x	3	x	1 to 2	1				1
butyl stearate	1	1	1	2 to 3	1	1	x	1	x	1	2	x
butylamine	2 to 3	2 to 3	2 to 3	x	x	x	3	1	3	1	1	3
butylene, liquid (butene)	2 to 3	2 to 3	2 to 3	3	1	1	x	1	x	1	1	2
butyraldehyde	x	x	3	3	x		1	1	3	1	1	1
butyric acid, aqu.*1	x	x	3	2 to 3	2	2	x	1	x	1	1	1
calcinated soda (sodium carbonate anhydrous)	2	2	1	1	1	1	1	1	1	2	1	
calcium acetate	2	2	2	2	x		1	1	2	1	1	1
calcium bisulphate, aqu.	3	1	3	1	1	1	1	1	1	1	1	1
calcium bisulphite, aqu.	3	2	1	1	1	2	1	1	1	1	1	1
calcium carbonate	1	1	1	1	1	1	1	1	1	1	1	1
calcium chloride, aqu.	3	1	1	1	1	1	1	1	1	1	1	1
calcium hydroxide, aqu. (slaked lime)	3	2	1	1	1	2	1	1	1	1	1	1
calcium hypochlorite, aqu.	x	x	2 to 3	1 to 2	1	1	1	1	3	1	1 to 2	1
calcium nitrate	1	1	2	1	1	1	1	1	1	1	1	1
calcium oxide = calcinated lime	1	1	1	1	1	1	1	1	1	1	1	1
calcium phosphate, aqu.	2	2	1	1	1		1	1			1	1
calcium sulphate (gypsum), aqu.	3	1	1	1	1	1 to 2	1 bis 2	1	2	1	1	1
calcium sulphide	2	1	2	1	1			1	1	1	1	
camphor (camphor oil)	x	x		3-x	3-x		3	1				1
cane sugar (sugar), aqu.	3	1	1	1	1	1	1	1	1	1	1	
carbamide, urea, aqu.	x	x	x	1	1	2	1	1			1	
carbitol (diethylene glycol monoethyl ether)	x	x	2	2	2	3	1	1	3	1	1	
carbolic acid (phenol)	3-x	3-x	3	2 to 3	1	x	x	1	3	1	2 to 3	1
carbolineum, aqu.	x	x	x	1	1	3	1	1	1	1		
carbon bisulphide	3	2	x	x	1	2 to 3	x	1	x	1	2	

*) at +20 °C ambient temperature

*1) as foodstuff, please order food-grade quality versions

*2) please ask for our detailed consultation

* registered trademark of El du Pont des Nemours and Company or one of its subsidiaries

	PUR-Ester	PUR-Ether	Silicone	Hypalon*	Viton*	PVC	PE	PTFE	Neoprene*	Kapton*	TPV	PE-EL
carbon dioxide solid (dried ice -80°C) resistant, but elastomers and plastomers become stiff to brittle												1
carbon dioxide, gaseous, wet and dry	1	1	1	1	1	1	1	1	1	1	1	1
carbon monoxide	1	1	1	2 to 3	1	1	1	1	2	1	1	
carbon tetrachloride (tetrachloromethane)	x	3	x	x	1	x	x	1	x	1	x	
carbonic acid see carbon dioxide												
Caro`s acid (peroxymonosulphuric acid)				2-3		1	x		x	1		x
castor oil, ricinus oil*1	1	1	1	1	1		2 to 3	1	2	1		1
caustic lime (calcium oxide)	1	1	1	1	1	1	1	1	1	1	1	
caustic potash see potassium hydroxide												
caustic soda see sodium hydroxide												
cellulose acetate (acetyl cellulose)	2	1	1				1	1	1	1	1	1
cellulube (hydraulic oil, phosphate ester based)	x	x	2 to 3	x	1	x	x	1	x	1	1	
ceolithe	x	x	1	x	1			1	1		1	
chile salpêtre (sodium nitrate)	2	1	3	1	1	1	1	1	2	1	1	1
china wood oil (wood oil)	3	2	3	3	1	3	2	1	x	1	2	2
chloral hydrate (trichloroacetaldehyde hydrate)	x	x		2	3	x	1	1	2	2		
chloramine	2	2		1	1						1	
chloric acid, aqu.				1	x	1	1	1	1	1	1	1
chlorinated hydrocarbons see specific desig.												x
applicable in general	x	x	x	x	2	x	x	1	x	1	x	
chlorinated lime (calcium hypochlorite)	x	x	2 to 3	1 to 2	1	1	1	1	3	1	1 to 2	1
chlorinated water 3%	x	3	2 to 3	3	1	1	2	1	x	1	1 to 2	2
chlorine dioxide	x	x	3	1	1	2 to 3	x	1	1	1		x
chlorine, dry	x	x	x	2-3	1	3-x	x	1	3-x	1	2-3	x
chlorine, wet	x	x	x	2-3	1	x	x	1	x	1	2-3	x
chloroacetic acid (monochloroacetic acid)	x	x	x	2	x	2	x	1	3	1	2	1
chlorobenzene (monochlor benzene)	x	x	x	x	1	x	3	1	x	1	x	1
chlorobiphenyl (clophen)	x	x	2	x	1	x	1	1	x	1	3	
chlorobromomethan	x	3	x	x	1	x	2	1	x	1	3	2
chlorocalcium (calcium chloride)	3	1	1	1	1	1	1	1	1	1	1	1
chloroethanol (ethylene chlorhydrine)	x	x	x	2	x	x	3	1	x	x	2	
chloroethyl (ethyl chloride)	x	x	x	x	1-2	3-x	3-x	1	3	1	2-3	1
chloroform (trichloromethane)	x	x	x	x	1	x	x	1	x	1	x	3
chloromethane (methyl chloride)	x	x	x	x	2	x	3	1	x	1	2	3
chloroprene (chlorinated butadiene)	x	x	x	2	1	x	3	1	x	1	3	3
chlorosulfonic acid	x	x	x	x	x	x	x	1	x	1	1 to 2	
chlorothene (trichloroethane)	x	x	x	x	1	3	x	1	x	1	2	
chromic acid 10%	x	3	3	2 to 3	2	1	3	1	3	1	1	3
chromic acid 25%	x	x	x	2 to 3	1	2	x	1	x	1	1	x
chromic acid 50%	x	x	x	2 to 3	1	x	x	1	x	1	2	x
chromium trioxid see chromic acid												
citric acid aqu.*1	3	1	1	1	1	1	1	1	1	1	1	
clophen (chlorobiphenyl)	x	x	2	x	1	x	1	1	x	1	3	
coal tar (see also hot tar, creosote)	3	3	x	x	1	2 to 3	2 to 3	1	3	1	2	
coconut grease and oil*1	2	2	1	3	1	1	1	1	2	1	2	1
cod-liver oil*1	1	1	2	2	1	1	1	1	2	1	2	1
common salt (sodium chloride)	3	2	1	1	1	1	1	1	1	3	1	1
compressed air, oil-saturated, to +°C	85	80	175	120	200	70	90	200		200	125	
copper acetate	x	x	x	2	x		1	1	2	1		1
copper chloride, aqu.	3	1	1	2	1	1	1	1	2	1	1*	1
copper cyanide	3	1	1	1	1	1	1	1	1	1	1*	1
copper fluoride	x	x	3	1	1		1	1			1	1
copper hydroxide	1	1	1				1	1		1	1*	1
copper nitrate, aqu.	x	3	1	1	1	2	2	1	1	1	1*	1
copper sulphate, aqu. (blue vitriol)	2	1	1	2	1	1	1	1	1	1	1*	1
corn oil*1	1	1	1	2	2	2	1	1	2	1	2 to 3	

*) at +20 °C ambient temperature

*1) as foodstuff, please order food-grade quality versions

*2) please ask for our detailed consultation

* registered trademark of El du Pont des Nemours and Company or one of its subsidiaries

1
2
3
4
5
6
7
8
9
10
11
12
13
14
15
16

Chemical Resistance

1 = excellent resistance

3 = medium resistance

2 = good resistance

x = non-resistant

	PUR-Ester	PUR-Ether	Silicone	Hypalon*	Viton*	PVC	PE	PTFE	Neoprene*	Kapton*	TPV	PE-EL
corn sugar (glucose, dextrose, grape sugar)*1	2	1	1	1	1	1	1	1	1	1	1	
cottonseed oil*1	1	1	1 to 2	1 to 2	1	1 to 2	1	1	2 to 3	1	2	1
cow suet	1	1	3	1 to 2	1	2	2 to 3	1	3	1	2	
creosote	3	3	x	x	1	2-3	2-3	1	3	1	2	2
cresols, cresylic acids	x	x	x	x	1	x	2 to 3	1	3	1	2	2
crotonaldehyde (2-butenal)	3-x	2 to 3		1	1	x	1	1	1		1	1
crude oil, high aromatic	2	2	x	2	1	3	3	1	3	1		
cumene (isopropylbenzene)	3	3-x	x	x	1	x	x	1	x	1	x	x
cupric hydroxide (mountain blue)	1	1	1				1	1		1	1*	1
cyankali (potassium cyanide)	3	2	1	1	2	1	1	1	1 to 2	3	1	1
cyclohexane (hexahydrobenzene)	2	2	x	x	1	x	2	1	x	1	3-x	1
cyclohexanol (hexaline)	3	x	2 to 3	1 to 2	1	x	1	1	2	1	2	1
cyclohexanone	3	x	x	x	x	x	2 to 3	1	x	1	2 to 3	1
cyclohexylamine	x	x	x	3-x	x	1		1			x	
decalin (decahydronaphthalene)	1	1	x	x	1	1	2	1	x	1	x	
detergents, synth. 20°C	3	2	1	1	1	1	1	1	2	1	1	
dextrose (glucose, corn sugar, grape sugar)*1	2	1	1	1	1	1	1	1	1	1	1	1
diacetone alcohol	3	2	2	2	x	x	1	1	3	1	1	1
dibenzyl ether	2 to 3	2 to 3	2	x	1	x		1	x	1	3	
dibutyl amine	x	x	3	x	x		x	1	x	1	2	x
dibutyl phthalate	x	3	2	3-x	2	3	2	1	x	1	2	
dibutyl sebacate	x	x	2	x	2	3	1	1	x	1	2	1
dichlorobenzene	x	x	x	x	2 to 3	x	3	1	x	1	3	1
dichloroethane	x	x	x	x	2-3	x	2-3	1	x		3	1
dichloroethylene (dichloroethene)	x	x	x	x	2	x	x	1	x	1	3	x
dichloro-isopropyl ether	2	2	x	x	3		3	1	x	1	2	x
dichloromethane (methylene chloride)	x	x	x	x	2	x	x	1	x	1	3	3
diesel oil	1	2	3	3	1	3	2	1	x	1	3	1
diethanolamine			2 to 3				1	1		1	2	1
diethyl ether (ether)	2	2	x	3-x	3-x	3	x	1	3	1	2	1
diethyl sebacate			2	x	2			1	x	1	2	1
diethylamine	x	3	2	3	2	x	3-x	1	2	1	1	1
diethylbenzene	x	x	x	x	1	1	x	1	x	1	x	1
diethylene glycol monoethyl ether (carbitol)	x	x	2	2	2	3	1	1	3	1	1	1
diethylene glycol (diglycol)	3	3	2	2	1	3	1 to 2	1	1	1	1	1
diglycolic acid, aqu.	x	x	3	2	1	2	1	1			1	1
dilutions for paints and lacquers determine composition												
dimethyl ether (methyl ether)	2	2		3	3	x	2	1	x	1	1	2
dimethyl formamide (DMF)	x	3	2 to 3	3	3	x	1	1	x	1	1	1
dimethyl heptanone (diisobutyl keton)	x	x			x			1				
dimethyl phthalate	3	3	3	x	2	3		1	x	1	2	
dimethyl sulphoxide (DMSO)	x	x	x		x	x	2	1	2-3		1	
dimethylamine			2	x	x	x	3	1	x	1	1	3
dimethylaniline (xylidine)	x	x	2 to 3	3	1	x		1	x	1	2	x
dioctyl phthalate (DOP)	2 to 3	2 to 3	3	x	1 to 2	3	2	1	x	1	2	1
dioctyl sebacate	2	2	3	x	2			1	x	1	2	1
dioxane (diethylene dioxide)	x	x	x	x	x	x	1	1	x	1	2	1
dipentene (limonene)	x	x	x	3	1			1	2		x	
diphenyl	x	x	x	3	1	x	2	1	x	1	3	2
diphenyl oxid (diphenyl ether)	x	x	2	x	2 to 3	x	2 to 3	1	x	1	2	1
dipropylene glycol			2	1	1		1	1	1	1	1	1
dodecyl alcohol (lauryl alcohol)			2 to 3		1		2	1	1	1	3	1
DOWTHERM A (glycole)	x	3-x	x	2 bis 3				1	2 to 3		x	
drilling oil: determine chem. composition												
Eau de Javelle (potassium hypochlorite)	3	2	2	2 to 3	1	1	3	1	2 to 3	3	1 to 2	
epichlorohydrin, liquid	x	x	x	x	x	x	1	1	x	1	1	1
epsom salt (magnesium sulphate)	1	1	1	1	1	1	1	1	1	1	1	1

*) at +20 °C ambient temperature

*1) as foodstuff, please order food-grade quality versions

*2) please ask for our detailed consultation

* registered trademark of El du Pont des Nemours and Company or one of its subsidiaries

	PUR-Ester	PUR-Ether	Silicone	Hypalon*	Viton*	PVC	PE	PTFE	Neoprene*	Kapton*	TPV	PE-EL
esters see specific designations, applicable in general	2	2	x	3-x	3-x	2-3	2-3	1	2	1	2	
ethane (gas)	2	2	3	2 to 3	1	1	1	1	2	1	2	
ethanol (ethyl alcohol)	2	2	2	1	1	2-3	1-2	1	1	1	1	1
ethanolamine (2-aminoethanol)	x	x	2 to 3	2 to 3	3	3	1	1	2 to 3	1		
ethene (ethylene)	1	1	2	x	1	1	1	1	2 to 3	1	2	1
ethers see specific designations, applicable in general	2	2	x	3-x	3-x	2-3	2-3	1	2	1	2	
ether (ethyl ether, diethyl ether)	2	2	x	3-x	3-x	3	x	1	3	1	2	1
etheric oils *1	2	2	x	3	1	x	x	1	x	1	2	1
ethyl acetate	x	x	2	x	x	x	2	1	3	1	1	1
ethyl acrylate (acryl acid ethyl ester)	x	x	2	1	x	x	x	1	x	1	1	1
ethyl alcohol (denatured = spirits)*1	2	2	2	1	2 to 3	1 to 3	1	1	1	1	1	1
ethyl benzene	x	x	x	x	2	x	x	1	x	1	x	1
ethyl bromide (bromomethane)	2	2	x	x	1	x	2	1	x	1	2 to 3	2
ethyl chloride (chloroethane)	x	x	x	x	1 to 2	3-x	x	1	3	1	2 to 3	1
ethyl dichloride (dichloroethylene)	x	x	x	x	2	x	x	1	x	1	3	x
ethyl ether (ether)	2	2	x	3-x	3-x	3	x	1	3	1	2	1
ethyl glycol acetate	x	x			x		1	1		1	2	
ethyl mercaptan	x	x	3	2	x			1	x	1	2	
ethylene chloride (dichloroethylene)	x	x	x	x	2	x	x	1	x	1	3	1
ethylene chlorhydrine (chloroethanol)	x	x	x	2	x	x	3	1	x	x	2	1
ethylene diamine	x	x	2	2	2	x	1	1	2	1	1	1
ethylene (gas) (ethene)	1	1	2	x	1	1	1	1	2 to 3	1	2	1
ethylene glycol (glycol, ethane-1,2-diol)	2 to 3	2 to 3	1	1	1	1	1	1	1	1	1	1
ethylene oxid (1,2-epoxy methane), liquid	x	x	3-x	x	x	x	2 to 3	1	x	1	1	2
fats in general see oils and greases	x	x	x	x	x	x	1-2	1	x	1		
fatty acids, with >7 C-atoms, in general	2	1	3	2 to 3	1	1	3	1	3	1	2	2
fatty acids, with 1-7 C-atoms, in general	3-x	2 to 3	3	2 to 3	1	1	3	1	3	1	2	2
fatty alcohols (longchain, aliphatic alcohols)	3	2	2	2	2	2	1	1			3	1
fermented fruit juice*1	3	1	1	1	1	1	1	1	1	1	1	1
ferric chloride (ferri), aqu.	2 to 3	2	2	2	1	1	1	1	1	1	1	1
ferric sulphate, ferric vitriol, aqu.	2 to 3	2	2	1	1	1	1	1	1	1	2	1
fertilizing salt, aqu.	x	3		1	1	1	1	1			1	1
fish-liver oil*1	2	2	1	3	1	2	1	1	1		2	1
fluorhydric acid see hydroflouric acid												
fluorine, liquid	x	x	x		2	2 to 3	x	1	x	1	x	1
fluorobenzene	x	x	x	x	1			1	x	1	x	
fluoroboric acid 65%		x	x	1 to 2	2	1	1	1	2	1	x	1
fluorosilicic acid, aqu.	x	x	2 to 3	1 to 2	1	2 to 3	2	1	2	1	1	
formaldehyd (methanal)	2 to 3	2 to 3	1 to 2	1 to 2	2 to 3	2	1	1	2	1	1	1
formaline (30-40% aqu. formaldehyd solution with 8 -12 % methyl alcohol additive)	3	2	2	2	1	1	1	1	2	1	1	
formamide	x	x		1	2 to 3	x	1	1			1	1
formic acid:												
0,03	2	1	1	1	2	1	1	1	1		1	1
0,1	3	2	2	1 to 2	3	1 to 2	1	1	1		2	1
1	x	x	x	x	x	2 to 3	1	1	1	2-x		1
freons and frigenes ask for detailed advisory												
frost protection agents s. exact chem. designation												
fruit juices*1	3	1	1	1	1	1	1	1	1	1	1	1
fruit pulp*1	3	1	1	1	1	1	1	1	1	1	1	1
fuel see gasoline												
fuming sulphuric acid: (oleum)	x	x	x	x	1	x	x	1	x	1	x	x
fungi (microbes)	x	1	3	1	1	1	2 to 3	1			2 to 3	2
furan	x	x	x	x	x	1	x	1	x	x		x
furfural alcohol (furfurol)	x	x	2	3	3	1	x	1	3	x	2	1
gallic acid	3	3	2 to 3	2	1	1 to 2	1	1 to 2	2 to 3	1	2	
gasoline in general (see specific designations)	1-2	1-2	3-x	2-x	1	3-x		1	1-2		x	1

*) at +20 °C ambient temperature

*1) as foodstuff, please order food-grade quality versions

*2) please ask for our detailed consultation

* registered trademark of El du Pont des Nemours and Company or one of its subsidiaries

1
2
3
4
5
6
7
8
9
10
11
12
13
14
15
16

Chemical Resistance

1 = excellent resistance

3 = medium resistance

2 = good resistance

x = non-resistant

	PUR-Ester	PUR-Ether	Silicone	Hypalon®	Viton®	PVC	PE	PTFE	Neoprene®	Kapton®	TPV	PE-EL
gasoline, lead-free	1	1	x	2-3	1	2-3	1	1	2-3		2-3	
gasoline, super	2-3	2-3	x	2-3	1	1	1	1	2-3		2-3	
gasoline, ASTM fuel A (isooctan, free of aromatics)	1	1	x	1	1	3-x		1	1		x	
gasoline, ASTM fuel B	x	x	x	x	1	3-x		1	x		x	
gasoline, ASTM fuel C	x	x	x	x	1	3-x		1	x		x	
gasoline, diesel, heating oil	1	1	3	2	1	3-x	2	1	x	1	x	1
gasoline, aviation (kerosene)	1	1 to 2	x	2	1	3	2	1	2	1	x	1
gasoline, high aromatic	3	2 to 3	x	2 to 3	1	2 to 3	2 bis 3	2	1	1	x	
gasoline, low aromatic	2	2	x	x	1	3	x	1	1	1	x	
gasoline, test- (heavy g., white spirit, mineral turpentine)	1-2	1-2	x	x	1	3	1-2	1			x	
gasoline/benzene (50/50)	3	3	x	x	2	3		1			x	
gasoline/benzene (60/40)	2	2	x	x	2	3		1			x	
gasoline/benzene (70/30)	2	2	3	x	1	3		1			x	
gasoline/benzene (80/20)	2	3	3	x	1	3	3	1			x	3
gasoline/benzene/ethanol (50/30/20)	3	3	x	3-x	x	3		1			3-x	
gelatins, aqu.*1	3	1	1	1	1	1	1	1	1	1	1	1
glacial acetic acid (acetic acid pure)	x	x	2 to 3	3	x	x	x	1	x	1	1	1
Glauber's salt (sodium sulphate)	3	1	1	1	1	1	1	1	1	1	1	1
glucose (dextrose, corn sugar, grape sugar)*1	2	1	1	1	1	1	1	1	1	1	1	1
glue, animal	2	2	1	1	1	1	1	1	1	1	1	1
glycerine (glycerine, propane-1,2,3-triol)	1	1	1	1	1	1	1	1	1	1	1	1
glycine (amino acetic acid), aqu. 10%	x	x	2 to 3	2 to 3	1	1		1			1	
glycols determine exact designation, applicable in general	2	2	1-2	1	1	2	1	1	2	1	1	
glycolic acid (hydroxy acetic acid), 30%	x	3-x	1	1	1	1	1	1			1	1
grape juice unfermented*1	3	1	1	1	1	1	1	1	1	1	1	1
grape sugar (glucose, corn sugar, dextrose)*1	2	1	1	1	1	1	1	1	1	1	1	1
greases in general, see oils and greases	x	x	x	x	x	x	1-2	1	x	1		
gypsum (calcium sulphate)	3	1	1	1	1	1 to 2	1 bis 2	1	2	1	1	
halogenes (look at: fluorine, chlorine, bromine, iodine)												
halogenated hydrocarbons see spec. design. applicable in general	x	x	x	x	1-2	x	x	1	x	1	3	
heavy gasoline (white spirit or mineral turpentine)	1 to 2	1 to 2	x	x	1	3	1 to 2	1			x	
helium	1	1	1	1	1	1	1	1	1	1	1	1
heptane	2	2	x	2	1	2 to 3	2 to 3	1	2 to 3	1	x	1
hexahydrobenzene (cyclohexane)	2	2	x	x	1	x	2	1	x	1	3-x	
hexaldehyde	2	3	3	2	x		1	1	2	1	2	1
hexaline (cyclohexanol)	3	x	2 to 3	1 to 2	1	x	1	1	2	1	2	
hexane (n-hexane)	2	2	x	1 to 2	1	1 to 2	3	1	1 to 2	1	x	1
hexanol (hexyl alcohol)	3	x	2 to 3	2	2	2	1	1	1	1	2	1
hexane-triol	x	x	1	1	1	1	1	1			1	
hexene	1	1	x	3	1		1	1	2			1
hot air see air												
hot bitumen to °C	x	x	x	x	180	x	x	200	x	200	x	
hydraulic oils and -liquids:												
-glycol based	1	1 to 2	2					1		1	1	1
-mineral oil based	1	1	3	2	1	3	3	1	2	1	3	3
-phosphate ester based (pydraul)	x	x	2 to 3	x	1	x	x	1	x	1	1	1
hydrazines (diamides)	x	x	3	2	2 to 3	1	1	1	2 to 3	1	1	1
hydrazine hydratee, aqu.	x	x	3	1	1	1	1	1	2	1	1	1
hydrobromic acid	x	3	3	1	1	2 to 3	1 bis 2	1	1	1	1	1
hydrocarbons aliphatic general (see spec. designation.)	1-2	2	3-x	3	1	2-3	3-x	1	3	1	2-x	
hydrocarbons aromatic general (see spec. designation.)	3-x	3-x	x	3-x	1-2	x	x	1	3	1	3-x	

*) at +20 °C ambient temperature

*1) as foodstuff, please order food-grade quality versions

*2) please ask for our detailed consultation

* registered trademark of El du Pont des Nemours and Company or one of its subsidiaries

	PUR-Ester	PUR-Ether	Silicone	Hypalon*	Viton*	PVC	PE	PTFE	Neoprene*	Kapton*	TPV	PE-EL
hydrocarbons halogenated general (see spec. designation.)	x	x	x	x	1-2	x	x	1	x	1	3	
hydrochloric acid 15%	3	2	3	1 to 2	1	1	1	1	3	1	1	
hydrochloric acid 38% (conc.)	x	x	3	1 to 2	1	2	1 to 2	1	3	1	1	
hydrochloric acid, (hydrochlorous) gaseous	3	2	1	1 to 2	1	1	1	1	2	1	1	
hydrocyanic acid see prussic acid												1
hydrofluoric acid 10%	x	2	2 to 3	1	1 to 2	1 to 2	1 to 2	1	2	1	1	1
hydrofluoric acid 30%	x	2	3	1 to 2	1 to 2	2	1 to 2	1	3	1	2	1
hydrofluoric acid 75%	x	3	x	2	2	3	3	1	x	1	3	x
hydrofluoricsilicic acid, aqu.	x	x	2 to 3	1 to 2	2 to 3	2 to 3	2	1	2	1	1	
hydrogen (gaseous)	1	1	3	1	1	1	1	1	1	1	1	1
hydrogen cyanide see prussic acid												1
hydrogen peroxide 10%	x	2	1	2	1 to 2	1	2	1	x	1	1 to 2	1
hydrogen peroxide 30%	x	2	1 to 2	2	1	2	2 to 3	1	x	1	2 to 3	1
hydrogen sulphide, dry	x	3	2 to 3	1 to 2	1	x	1	1	2 to 3	1	1	1
hydrogen sulphide, wet	x	3-x	1	1 to 2	1	x	1	1	2 to 3	1	1	1
hydroquinone, aqu.	x	x	3	2 to 3	2	2	1	1	3		3	1
hydroxylamine sulphate, aqu.	x	x	1	1	1	1		1			1	
ink	1	1	1	1	1	3	1	1			1	1
iodine tincture (5-10% alcohol iodine solution)	x	x	x	2	1	2 to 3	2 bis 3	1	3	1	1	2
isobutanol (isobutyl alcohol)	3	x	1	1	1	1	1	1	1	1	2	1
isooctane	2	2	3	2	1	1	3	1	3	1	x	1
isooctanol (isooctyl alcohol)	3	3	2	2	1	1	1	1	3	1	2	1
isophoron	3-x	3-x	3-x	x	x			1	x	1	3	
isopropanol (isopropyl alcohol)	2	3	1	1	1	2	1	1	2	1	1	1
isopropyl acetate	3	3	3	x	x	3	2 to 3	1	x	1	1	1
isopropyl benzene (cumen)	3	3-x	x	x	1	x	x	1	x	1	x	x
isopropyl chloride	3	3	x	x	1			1	x	1	2	
isopropyl ether	2	2	x	3	3	2 to 3	2 bis 3	1	x	1	2	1
Javelle lye (potassium hypochlorite)	3	2	2	2 to 3	1	1	3	1	2 to 3	3	1 to 2	n.a.
jet fuel DPI-IPS			x	x	1	2 to 3	x	1	2 to 3	1		
kerosene	2	1	3	2 to 3	1	1	3	1	2	1	x	1
ketones see specific designations, applicable in general	3-x	x	2-x	x	x	x	2-3	1	3-x	1	2-3	1
lacquers, composition must always be determined												
lactic acid* ¹	x	2	2	2	1	3	2	1	3	1		1
lanolin (wool grease)	1	1	3	3	1	2	1 to 2	1	3	1	2	1
lard (oils, animal)	1	1	3	1 to 2	1	2	2 to 3	1	3	1	2	1
laughing-gas (nitrous oxide)	1	1	1	1	1	1	1	1	1	1	1	1
lauryl alcohol (dodecyl alcohol)			2 to 3		1		2	1	1	1	3	
lavender oil* ¹	x	x	x	2 to 3	1			1	2 to 3			
lead acetate, aqu.	3	1	1	1	1	1	1	1	2	1	1	1
lead arsenate, aqu.	3	1	1			1	1	1	1	1	1	1
lead nitrate	2	1	2	1	1	1	1	1	1	1	1	1
lead sulphate	1	1	1	1	1	1	1	1	1	1	1	1
lignite tar oil (see coal tar)	3	3	x	x	1	2 to 3	2 to 3	1	3	1	2	2
lime, quick (calcium oxide)	1	1	1	1	1	1	1	1	1	1	1	
lime, slaked (calcium hydroxide)	3	2	1	1	1	2	1	1	1	1	1	
limestone (calcium carbonate)	1	1	1	1	1	1	1	1	1	1	1	
limonene 90% (citric oil)	2	2	x			x	2-3	1			2	
linseed oil* ¹	1	2	1	2	1	2	2	1	2	1	2 to 3	1
liquefied petroleum gases (LPG) see chem. identification of the gases												
lithium chloride, aqu.	x	x	1	1	1	x	1	1	1		1	1
lubricants and greases see mineral oils, attend additives												
lyes see exact designation, applicable in general	2-x	2	1-2	1-2	2	1-2	1-2	1	2	2	1	1

*) at +20 °C ambient temperature

*¹) as foodstuff, please order food-grade quality versions

*²) please ask for our detailed consultation

* registered trademark of El du Pont des Nemours and Company or one of its subsidiaries

Chemical Resistance

1 = excellent resistance

3 = medium resistance

2 = good resistance

x = non-resistant

	PUR-Ester	PUR-Ether	Silicone	Hypalon*	Viton*	PVC	PE	PTFE	Neoprene*	Kapton*	TPV	PE-EL
machine oil, see oils, mineral												
magnesium chloride, aqu.	3	1	1	1 to 2	1	1 to 2	1	1	1 to 2	1	1	1
magnesium hydroxide	3	1	1	1	1	1	1	1	1	1	1	1
magnesium silicate (talc)	1	1	1	1	1	1	1	1	1	1	1	1
magnesium sulphates	1	1	1	1	1	1	1	1	1	1	1	1
magnesium sulphite, aqu.	3	1	1	1	1	1	1	1	1	1	1	1
maize oil*1	2	2	2	1	1	2	2	1	1			1
maleic acid, aqu.	x	x		x	1	1	2	1	3-x	1	1	1
maleic anhydride				x	3				x		2	
manure	x	1	1	1	1	1	1	1	1	1	1	
margarine-greases and oils*1	1	1	3	1 to 2	1	2	37714	1	2	1	2	1
marsh gas (mine damp, methane)	2	3	3-x	2-3	1	1-2	1	1	2-3	1	2	1
mash*1	3	1	1	1	1	1	1	1	1	1	1	1
MEK (methyl ethyl ketone)	x	x	x	x	x	x	2	1	3	1	1	1
melamine			3		1	x		1	x			
menthol	3	3	x	1	1		1	1			1 to 2	1
mercury	1	1	1	1	1	2	1	1	1 to 2	1	1	1
mercuric chloride (sublimite)	1	1	1	1 to 2	1	2	1	1	1 bis 2	1	1	1
mercurious nitrate	2	1	1		1	1	1	1		1	1	1
mesityl oxide	x	x	x	x	x	x	3	1	x	1	3	3
methane (gas)	2	3	3-x	2 to 3	1	1 to 2	1	1	2 to 3	1	2	1
methanol (methyl alcohol)	2	3	1	1	2	1	1	1	1	1	1	1
methyl acetate (acetic acid methyl ester)	x	x	x	x	x	x	2	1	2	1	1	1
methyl acrylate	x	x	x	x	x	x		1	2			
methyl alcohol	2	3	1	1	2	1	1	1	1	1	1	1
methyl bromid (bromomethane)	x	x	x	3	2	x	3	1	x		x	3
methyl chloride (chloromethane)	x	x	x	x	2	x	3	1	x	1	2	3
methyl chloroform (trichloroethane)	x	x	x	x	1	3	x	1	x	1	2	1
methyl ethyl ketone (MEK)	x	x	x	x	x	x	2	1	3	1	1	1
methyl glycol (methylcellosolve)	x	x	x	3	x	x	2	1	2 to 3	1	1	
methyl glycol acetate	x	x	x		x			1	x	1	1	
methyl isobutyl keton	x	x	3	x	x	x	2 to 3	1	x	1	2	2
methyl oxiran (propylene oxide)	x	x	x	x	x		2	1	x	1	1	
methyl phthalate (dimethyl phthalate)				x	2			1	x	1	2	
methylamine, aqu.	x	x	x	1	2 to 3	3	1	1	2	1	1	1
methylated spirits (ethanol denaturated)	2	2	2	1	1	2-3	1-2	1	1	1	1	
methylene chloride (dichloromethane)	x	x	x	x	2	x	x	1	x	1	3	3
microbes	x	1	3	1	1	1	2 to 3	1			2 to 3	2
milk of lime (lime water) see calcium hydroxide												1
aqu. milk*1	3	2	1	1	1	1	1	1	1	1	1	1
mineral oil see oils, mineral												
mixed acid II (sulphuric acid/phosphoric acid/water)	x	x		1	1	1	3	1	2	1	2	1
mixed acid I (sulphuric acid/nitric acid/water)	x	x	x	x	x	x	x	1	1 to 2	1	3	1
molasses*1	1	1	1	1	1	1	1	1	1	1	1	1
monochloroacetic acid	x	x	x	2	x	2	x	1	3	1	2	1
monochlorobenzene	x	x	x	x	1	x	3	1	x	1	x	
monochloromethane (methyl chloride)	x	x	x	x	2	x	3	1	x	1	2	
mono ethylene glycol	1											
monostyrol (styrol, styrene, monomeric)	x	3	x	x	2	x	x	1	x	1	x	
morpholine	x	x	x	2	2	x	1	1	3		1	1
motor oil see oil and greases, clarify mineral additives												
mountain blue (cupric hydroxide)	1	1	1				1	1		1	1*	1
must fermented (fermented fruit juice)	3	1	1	1	1	1	1	1	1	1	1	
must, unfermented*1	3	1	1	1	1	1	1	1	1	1	1	1
mustard	1	1		1	x	1 to 2	1	1	1			1
myristyl alcohol, myristic alcohol (tetradecanol)	1	1	2	1	1	1		1	1	1	2	

*) at +20 °C ambient temperature

*1) as foodstuff, please order food-grade quality versions

*2) please ask for our detailed consultation

* registered trademark of El du Pont des Nemours and Company or one of its subsidiaries

	PUR-Ester	PUR-Ether	Silicone	Hypalon®	Viton®	PVC	PE	PTFE	Neoprene®	Kapton®	TPV	PE-EL
naphtha	2	2	3	x	1	2 to 3	2 to 3	1	3	1	3-x	1
naphthalene (stone oil)	2	2	3	2-3	1	x	x	1	x	1		1
natron (sodium bicarbonate)	x	2	1	1	1	1	1	1	1	2	1	
natural gas, wet	2	1-2	2-3	1	1	1	2	1	1	1	2	1
natural gas, dry	1	1	2-3	1	1	1	1	1	1	1	2	1
n-hexane	2	2	x	1 to 2	1	1 to 2	3	1	1 to 2	1	x	
nickel acetate	3	2	2	x	x		1	1	2		2	1
nickel chloride, aqu.	3	2	1 to 2	1 to 2	1	1	1	1	2	1	2	1
nickel sulphate, aqu.	2 to 3	2	1	1	1	1	1	1	1	1	1	1
nitrate (nitrate of sodium)	2	1	3	1	1	1	1	1	2	1	1	1
nitrating acid (mixed acid I)	x	x	x	x	x	x	x	1	x	1	3	
nitric acid 10%	3	3	3	1 to 2	1	1	2	1	2	1	1	1
nitric acid 25%	x	x	x	2	1 to 2	1	2 to 3	1	3	1	1	1
nitric acid 50% (aqua fortis)	x	x	x	3	1 to 2	2 to 3	2 to 3	1	x	1	1 to 2	2
nitric acid 60%	x	x	x	3-x	2	2 to 3	x	1	x	1	3-x	
nitric dilution	2	2	x	1		x	2 to 3	1	1		2 to 3	
nitro-benzene	x	x	x	x	2	x	3	1	x	1	1	1
nitrogen	1	1	1	1	1	1	1	1	1	1	1	1
nitrogen oxides (nitrous gases)	x	x	x	3	3	x	1	1	x		x	1
nitro-glycerin	x	x	x	1	1	2	2	1			x	1
nitrohydrochloric acid (aqua regia)	x	x	3	3	2	2 to 3	2	1	3	1	3	
nitro-methane	x	x	x	2 to 3	x	2 to 3	1	1	3			1
nitro-propane	x	x	x	x	x			1	x	1	1	
nitro-toluole	x	x		x	3	x	1	1	x	1	x	
nitrous fumes (nitrogen oxides)	x	x	x	3	3	x	1	1	x		x	1
nitrous oxide (laughing gas)	1	1	1	1	1	1	1	1	1	1	1	
N-methylpyrrolidone (NMP)	3	3			3	3		1				
nonyl alcohol (nonanol)	x	x	2	2	1		2	1	3	1	2	1
octane	1	1	x	x	1		1	1	x	1	x	1
octanol = octyl alcohol	x	x	2	1	1	x	1	1	1	1	2	1
oils and greases:												
-animal*1	1	1	3	1 to 2	1	2	2 to 3	1	3	1	2	1
-ASTM-oil Nr. 1 20°C	1	1	2	1	1	2	2	1	1	1	3	
-ASTM-oil Nr. 2 20°C	1	2	3	2	2	2	3	1	1	1	x	
-ASTM-oil Nr. 3 20°C	1	2	3	2	2	2	3	1	x	1	x	
-crude oil, high aromatic	2	2	x	2	1	3	3	1	3	1		
-diesel oil	2	2	3	3	1	3	2	1	x	1	3	
-heating oil	2	2	3	3	1	3	2	1	x	1	3	
-hydraulic oils and -liquids:												
-glycol based	1	1 to 2	2					1		1	1	
-mineral oil based	1	1	3	2	1	3	3	1	2	1	3	
-phosphate ester based (pydraul)	x	x	2 to 3	x	1	x	x	1	x	1	1	
-mineral, without additives, at 20°C	1	1	2 to 3	2 to 3	1	2	2	1	x	1	2 to 3	
-mineral, without additives, to °C	60	60	x	150	200	x	30	200		200	100	
-silicon based	1	1	2 bis 3	1	1	1	1	1	2 to 3	1	1	
-transformer oils (pyranols)	2	2	x	x	1	3	3	1	2 to 3	1	x	
-vegetable *1	1-2	1-2	2-3	2	1	2	2-3	1	2-3	1	2	
oil of bitter almonds (benzaldehyde)	3	3	2 to 3	x	2 to 3	3	2	1	x	1	2	1
oleic acid, olein	1	1	x	3-x	2	2	2 to 3	1	x	1	2	
oleum (fuming sulphuric acid)	x	x	x	x	1	x	x	1	x	1	x	x
oleum vapours	x	x	x	3	3	3	x	1	x	1	x	x
olive oil*1	1	1	2	1 to 2	1	1	1	1	2	1	2	1
oxalic acid, aqu.	x	x	2	2	1	2	1	1	3	1	1	1
oxidant see specific designations, applicable in general	2-3	2-3	2-3	2	1	2	2-3	1	3	1	1	
oxirane (ethylene oxide)	x	x	3-x	x	x	x	2 to 3	1	x	1	1	2
oxygen pure to +°C	80	80	175	120	200	70	70	200		200	100	

*) at +20 °C ambient temperature

*1) as foodstuff, please order food-grade quality versions

*2) please ask for our detailed consultation

* registered trademark of El du Pont des Nemours and Company or one of its subsidiaries

1
2
3
4
5
6
7
8
9
10
11
12
13
14
15
16

Chemical Resistance

1 = excellent resistance

3 = medium resistance

2 = good resistance

x = non-resistant

	PUR-Ester	PUR-Ether	Silicone	Hypalon*	Viton*	PVC	PE	PTFE	Neoprene*	Kapton*	TPV	PE-EL
ozone (atmospherical concentrations)	1-2	2-3	1	1	1	2	3	1	2-3	1	1	x
ozone 100%	3	3-x	1	2-3	1	3	x	1	x	1	2	x
palm oil, palm pip oil*1	1	2	1	3	1	1 to 2	1 to 2	1	x	1	2	1
palmitic acid	1	1	3	3	2	2	1	1	3	1	1	1
paraffin, paraffin oils	1	2	2	3	1 to 2	1 to 2	2 to 3	1	2 to 3	1	2	1
paraformaldehyde	2	1	1		2		1	1	2	1	1	1
pectine	1	1		1	1	1		1			1	
pentachlorophenol	x	x	3				1 to 2	1		1	2	
pentane	3	x	x	2	1	1	x	1	2	1	3	x
pentanols (amyl alcohols)	3	3	3	1	2	1	1 to 2	1	1	1	1	1
peracetic acid (mixture, cold disinfection)						3-x	2	1			2-3	
perborate (sodium borate)	1	1	2	2	1	1	1	1	1	2	1	
perchloric acid, aqu.	x	x	x	1 to 2	1	2 to 3	2	1	2	1	1	2
perchloroethylene (tetrachloroethylene)	x	x	x	x	1	3	x	1	x	1	x	
perhydrol see hydrogen peroxide												
permanganate (potassium permanganate) 10 %	3	1	1	1	1	1	1	1	2	2	1	1
peroxomonosulphuric acid				2 to 3		1	x		x	1		
petrol see gasoline												
petroleum, without additives, at 20°C	1	1	2 to 3	2 to 3	1	2	2	1	3	1	2 to 3	
petroleum, without additives, to °C	65	60	x	150	200	x	30	200		200	100	
petroleum spirit (white spirit, solvent naphta)	1 to 2	1 to 2	x	x	1	3	1 to 2	1			x	
phenol (carbolic acid), aqu.	3-x	3-x	3	2 to 3	1	x	x	1	3	1	2 to 3	1
phenyl ether (diphenyl oxide)	x	x	2	x	2 to 3	x	2 to 3	1	x	1	2	1
phenylbenzene (biphenyl)	x	x	x	x	1	x		1	x		1	
phorone (diisopropylidene acetone)	x	x	x	x	x			1	x		1	
phosphoric acid 3%	2 to 3	2	2	2	1	1	1	1	1	1	1	1
phosphoric acid 50%	3	2	3	2	1	1	2	1	2	1	1	1
phosphoric acid 85%	x	x	3	2	1	1	2	1	3	1	1	
phosphoric alumina (aluminium phosphates, aqu.)	2	1	1	1	1	1	1	1	1	1	1	
phosphorus oxychloride	x	x	x	3	1	x	2 to 3	1	3	1	1	x
photo-emulsions, in general (see exact chem. designation)	x	x	2	1	2	1 to 2	1	1	1 to 2	1	1	
phthalic acid			2	1	x	2	1	1	1		1	
phthalic acid anhydride, aqu.				1	x	3	1	1	1	1	1	
phthalic acid ester (phthalates)	x	3	x	1	1	1	1	1			2 to 3	1
picric acid	2 to 3	2 to 3	3	2	1 to 2	2 to 3	1	1	2	1	1	1
pigs fat (oils, animal)	1	1	3	1 to 2	1	2	2 to 3	1	3	1	2	1
pine oil*1	1	1	x	x	1	3	3	1	x	1		
polychlorinated biphenyls (pyranols, transformer oils)	2	2	x	x	1	3	3	1	2 to 3	1	x	
potash (potassium carbonate)	3	2	1	1	1	1	1	1	1	3	1	
potassium acetate, aqu.	x	x	x	x	2 to 3	1	1	1	2 to 3	1	1	
potassium aluminium sulphate (alum)	2	1	1 to 2	1	1	1	1	1	2	3	1	1
potassium bicarbonate (potassium hydrogen carbonate)	2	2	1	1	1	1	1	1	1	3	1	1
potassium bichromate (potassium dichromate)	3	2	2	1 to 2	1	1	1	1	1	3	1	
potassium bisulphate, aqu.	x	3-x	2	1	1		1	1			1	1
potassium borate, aqu.	3	1	1	1	1	1	1	1	1	3	1	1
potassium bromate, aqu., 10%	x	x	2 to 3	1	1	1	1	1			1	1
potassium bromide, aqu.	2 to 3	1	1	1	1	1	1	1	1	3	1	1
potassium carbonate (potash)	3	2	1	1	1	1	1	1	1	3	1	1
potassium chlorate, aqu.	3	2	2	1	1	1	1	1	1	3	1	1
potassium chloride, aqu.	2	1	1	1	1	1	1	1	1	3	1	1
potassium chromate, aqu., 40%	x	x	2 to 3	1	1	1 to 2	1	1	1		1	1
potassium cyanide (cyankali), aqu.	3	2	1	1	2	1	1	1	1 to 2	3	1	1
potassium dichromate, aqu.	3	2	2	1 to 2	1	1	1	1	1	3	1	1
potassium hydroxide (caustic potash, -lye) 10%	2 to 3	2	3	1 to 2	1	2	1	1	1	3	1	

*) at +20 °C ambient temperature

*1) as foodstuff, please order food-grade quality versions

*2) please ask for our detailed consultation

* registered trademark of El du Pont des Nemours and Company or one of its subsidiaries

	PUR-Ester	PUR-Ether	Silicone	Hypalon*	Viton*	PVC	PE	PTFE	Neoprene*	Kapton*	TPV	PE-EL
potassium hydroxide (caustic potash, lye) 50%	x	3	x	1 to 2	2 to 3	2 bis 3	1	1	1	x	1	
potassium hypochlorite (Javelle)	3	2	2	2 to 3	1	1	3	1	2 to 3	3	1 to 2	3
potassium iodide, aqu.	3	2	2	1	1	1 to 2	1 to 2	1	1	2	1	1
potassium nitrate, aqu.	2 to 3	1	1	1	1	1	1	1	1	3	1	1
potassium perchlorate, aqu.	x	x	2	1	1	1		1			1	
potassium permanganate 10%, aqu.	3	1	1	1	1	1	1	1	2	2	1	1
potassium peroxy disulphate (potassium persulphate)	x	3-x	3-x	1	1	2	1	1			1	1
potassium phosphate (mono and dibasic)	1	1	x	1	1		1	1	1	3	1	1
potassium sulphate	1	1	1	1	1	1	1	1	1	3	1	1
potassium sulphite	1	1	1	1	1	1	1	1	1	3	1	1
propane gas	1	1	x	2 to 3	1	1	2	1	1	1	1	
propane, liquid	1	1	3	3	1	1	x	1	2 to 3	1	1	x
propanol (propyl alcohol)	2	3	1 to 2	1 to 2	1	1 to 2	1	1	1 to 2	1	1	
propargyl alcohol, aqu. 7%	x	x	2	2	1		1	1	1		2	1
propionic acid (propane acid)	x	x	x	3	1	1	1	1	x	1	1	1
propyl acetates (acetic acid propyl esters)	x	x	x	x	x		2	1	x	1	1	2
propyl alcohol (propanol)	2	3	1 to 2	1 to 2	1	1 to 2	1	1	1 to 2	1	1	
propylamine	x	x	x	x	x			1	x	1	1	
propylene (propene)	x	x	x	x	1	2		1	x	1	1	
propylene dichloride			x				x	1		1	2	x
propylene glycols (propandiols)	x	x	1	1	1	3	1 to 2	1	2 to 3	1	1	1
propylene oxide (methyloxiran)	x	x	x	x	x		2 to 3	1	x	1	1	2
prussic acid 20%	3	2	2 to 3	1 to 2	1 to 2	1 to 2	1	1	2 to 3	1	1	1
prussic acid 98% (conc.)	3	2	2 to 3	1 to 2	1 to 2	1 to 2	1	1	2 to 3	1	1 to 2	1
pydraul (hydraulic liquids phosphate ester based)	x	x	2 to 3	x	1	x	x	1	x	1	1	
pyranols (oils, transformer oils)	2	2	x	x	1	3	3	1	2 to 3	1	x	
pyrantone (diacetone alcohol)	3	2	2	2	x	x	1	1	3	1	1	
pyridine	x	x	x	3	3	x	1	1	x	1	2 to 3	1
pyrrol	x	x	2	3	3			1	3		1	
quick lime (calcium oxide)	1	1	1	1	1	1	1	1	1	1	1	1
radiation, radioactive	2	2	x	1		3	x	x	1		2	x
radiation, UV	2	2	2	1	1	2	3	1			x	3
radioactive radiation: applicable in general	2	3	x	x	x	x	3	x	x	x	1 to 2	x
rapeseed oil ^{*)}	2	2	x	2 to 3	1		x	1	2 to 3	1	2	x
raw sugar sap	x	3	1	1	1	1	1	1	2	1	1	1
redoil (aniline)	x	x	2	3	1 to 2	2 to 3	2 to 3	1	x	1	1	
ricinus oil, castor oil ^{*)}	1	1	1	1	1		2 to 3	1	2	1		1
rock salt	3	2	1	1	1	1	1	1	1	3	1	2
saccharose (sugar) aqu.	3	1	1	1	1	1	1	1	1	1	1	
sal ammoniac (ammonium chloride) aqu. 3%	3	1	1	2	1	1	1	1	1	1	1	1
salicylic acid (spiric acid), aqu.	2	1	1	1	1	2	1	1	2	1	1	1
salmiac (ammonium chloride)	3	1	1	2	1	1	1	1	1	1	1	1
salpêtre (potassium nitrate)	2 to 3	1	1	1	1	1	1	1	1	3	1	1
salt (table or common salt, sodium chloride)	3	2	1	1	1	1	1	1	1	3	1	1
salted water (brine, sea water)	3	2	1	1	1	1	1	1	1-2	1	1	1
sangajol = turpentine oil substitue, mineral	1 to 2	1 to 2	x	x	1	3	1 to 2	1			x	
seawater	3	2	1	1	1	1	1	1	1-2	1	1	1
sebacic acid ester	x	x		x	3-x	x		1			2	1
sewage	x	ask for advice	2	1	1	1	1	1	1	1	2	1
silicon dioxide (silicic acid, chert, silica)	1	1	1	1	1	1	1	1	1	1	1	
silicon oils and -greases	1	1	3	1	1	1	1	1	2-3	1	1	1
silver nitrate, aqu.	1	1	1	1	1	2	1	1	1 to 2		1	1
skydrol (hydraulic liquids, phosphate ester based)	x	x	2 to 3	x	1	x	x	1	x	1	1	
slaked lime (calcium hydroxide, aqu.)	3	2	1	1	1	2	1	1	1	1	1	1
soapsuds, -solution, detergents)	x	2	1	1	1	1	1	1	1	1	1	

*) at +20 °C ambient temperature

*) as foodstuff, please order food-grade quality versions

*) please ask for our detailed consultation

* registered trademark of El du Pont des Nemours and Company or one of its subsidiaries

1
2
3
4
5
6
7
8
9
10
11
12
13
14
15
16

Chemical Resistance

1 = excellent resistance

3 = medium resistance

2 = good resistance

x = non-resistant

	PUR-Ester	PUR-Ether	Silicone	Hypalon*	Viton*	PVC	PE	PTFE	Neoprene*	Kapton*	TPV	PE-EL
soda ash (sodium carbonate anhydrous)	2	2	1	1	1	2	1	1	1	2	1	1
soda lye see sodium hydroxide												
soda salpêtre (sodium nitrate)	2	1	3	1	1	1	1	1	2	1	1	1
soda, calcinated (sodium carbonate anhydrous)	2	2	1	1	1	1	1	1	1	2	1	1
soda, crystallised (sodium carbonate aqu.)	x	2-3	1	1	1	2	1	1	1	2	1	1
sodium bicarbonate (sodium-hydrogencarbonate), aqu.	x	2	1	1	1	1	1	1	1	2	1	
sodium bisulphate (sodium-hydrogensulphate)	x	x	1	1	1	1	1	1	1	2	1	
sodium bisulphite (sodium-hydrogensulphite), aqu.	x	x	1	1	1	1	1	1	1	2	1	
sodium borate (borax)	1	1	1 to 2	1 to 2	1	1	1	1	1	2	1	
sodium bromide				1 to 2	1	1 to 2	1	1	1		1	1
sodium carbonate (soda) aqu.	x	2-3	1	1	1	2	1	1	1	2	1	1
sodium chlorate, aqu.	3	2	1	1	1	1	1	1	1	3	1	
sodium chloride (muriate of soda, common or table salt)* ¹	3	2	1	1	1	1	1	1	1	3	1	1
sodium chlorite				1	1	3	2 to 3	1			2	2
sodium cyanide	3	3	1	1	1	1	1	1	1	3	1	1
sodium dichromate	3	3	2	1	1		1	1	1	3	1	1
sodium fluoride	3	2	2	1	1	1	1	1	1	3	1	1
sodium fluoroaluminat 10%	3	2 to 3	2		1	1	1	1	1	3	1	
sodium hydroxide (sod lye) 25%, 100°C	x	x	x	3	x	x	x	1	x	3	1	
sodium hydroxide (sod lye) 25%, 20°C	x	2	2	1	3	1	x	1	2	2	1	
sodium hypochlorite 10%	3	2	2	1	1	1	2	1	2 to 3	1	2 to 3	1
sodium hypochlorite 30%	x	3	3	1	2 to 3	1	2	1	1	1	x	
sodium metaphosphate	1	1	1	2	1	1	1	1	2	1	1	1
sodium nitrate, aqu.	2	1	3	1	1	1	1	1	2	1	1	1
sodium nitrite	2	1	1	1	1	1	1	1	1	1	1	1
sodium perborate	x	x	2	2	1	2	1	1	2	1	1	1
sodium percarbonate (bleaching agent)			2-3		1		1	1			1	
sodium peroxide	3	2	3	2	1 to 2	2	1	1	2 to 3	1	1	
sodium phosphate (see also trisodium phosphate)	2	2	x	2	1	1	1	1	2	1	1	1
sodium silicate, aqu.	x	3	1	1	1	1	1	1	1	1	1	1
sodium sulphide, aqu.	2	2		1	x	1	1	1	1	1	1	1
sodium sulphate (Glauber's salt), aqu.	3	1	1	1	1	1	1	1	1	1	1	1
sodium sulphite, aqu.	2	1	1	1	1	1	1	1	1	1	1	1
sodium thiosulphate (antichlorine)	3	2	1	1	1	1	1	1	1	1	1	1
solvent naphta (petroleum spirit, white spirit)	1 to 2	1 to 2	x	x	1	3	1 to 2	1			x	
solvents see specific designations												
soyabean oil* ¹	2	2	1	2 to 3	1	1	1 to 2	1	2 to 3	1	2	1
spindle oil (oils, mineral)												
spirits (ethanol, denaturated)	2	2	2	1	1	2-3	1-2	1	1	1	1	
spirits of ammonia (ammonia 25% in water)	x	x	1	3	1	1	1	1	2	x	1	
spruce needle oil	2	2	2	x	1 to 2	x	2	1				1
staining solution (20% nitric acid 4% hydrofluoric acid)	x	x		1				1	x		x	
starch syrup* ¹	2	2	1	1	1	1	1	1	1	1	1	1
starch, aqu.* ¹	1	1	1	1	1	1	1	1	2	1	1	1
steam of water to °C	x	x	120	100	150	x	x	200		200	135	90
stearin (stearic acid)	3	2	1 to 2	2 to 3	2	1 to 2	1 to 2	1	2	1	1	1
stone oil (naphthalene, liquid paraffine)	2	2	3	3	1	x	2 to 3	1	x	1		
styrene, monomer	x	3	x	x	2	x	x	1	x	1	x	
sublimate (mercury chloride)	1	1	1	1 to 2	1	2	1	1	1 to 2	1	1	
sugar aqu. * ¹ (see also raw sugar juice)	3	1	1	1	1	1	1	1	1	1	1	1
sulfonic acids, in general	x	x	1	1	2	1		1			2 to 3	1
sulfur dioxide see sulphuric acid												
sulfur trioxide (sulphuric acid anhydride)	3	2	2 to 3	3	1	1	1	1	x	1	1	3
sulfur, molten, 90°C	3	2	1	1	1	x	x	1	2	1	2 to 3	
sulphuric acid 10%	3	2	3	1	1	1	1	1	2	1	1	1
sulphuric acid 30%	x	2	x	1	1	1	1	1	2	1	1	1

^{*)} at +20 °C ambient temperature

^{*)} as foodstuff, please order food-grade quality versions

^{*)} please ask for our detailed consultation

* registered trademark of El du Pont des Nemours and Company or one of its subsidiaries

	PUR-Ester	PUR-Ether	Silicone	Hyalon*	Viton*	PVC	PE	PTFE	Neoprene*	Kapton*	TPV	PE-EL
sulphuric acid 50%	x	2	x	1	1	1	1	1	2	1	1	1
sulphuric acid 75%	x	x	x	1 to 2	1	2	2	1	2 to 3	1	1	2
sulphuric acid 90%	x	x	x	2	1	x	3	1	3	1	1	2
sulphuric acid conc. (oleum, fuming sulphuric acid)	x	x	x	3-x	1	x	3	1	x	1	x	2
sulphuric ether see ether												
sulphuric acid 10%, moist	3	2	2	1 to 2	2	2	1	1	3	1	1	1
sulphuric acid 75%, moist	x	x	3	2 to 3	2	2 to 3	2	1	3	1	1	2
table salt (sodium chloride)	3	2	1	1	1	1	1	1	1	3	1	1
talc (magnesium silicate)	1	1	1	1	1	1	1	1	1	1	1	1
tallow	1	1	1	1	1	1	1	1	1	1	2	1
tannic acid (tannin)	2 to 3	2	2	1 to 2	1 to 2	1	1	1	1 to 2	1	1	1
tar (see also hot tar)	x	x	2	x	1	2	2	1	3	1	x	1
tartaric acid, aqu.*1	3	1	1	1	1	1	1	1	1 to 2	1		1
tensides (washing or cleaning agents, synth.)	3	2	1	1	1	1	1	1	2	1	1	
test gasoline = white spirit	1 to 2	1 to 2	x	x	1	3	1 to 2	1			x	1
tetrachlorocarbon (tetrachloromethane, tetra, carbon tetra chloride)	3	3	x	x	1	x	x	1	x	1	x	
tetrachloroethans	x	x	x	x	2	3	x	1	x		x	1
tetrachloroethylene (perchloroethylene)	3	3	x	x	1	x	2 to 3	1	x	1	x	1
tetrahydrofurane (THF)	3	3	x	x	x	x	3	1	x	1	2	1
tetraline = tetrahydronaphthalene	x	x	x	x	1	1	3	1	x	1	x	1
thionyl chloride	x	x	x	x	3	x	x	1	x		x	x
thiophene	x	x	x	x	x	x	1	1			x	1
tin-II-chloride, aqu.	3	1	1	2	1	1	1	1	1	1	1	1
toluol	x	x	x	x	1	x	3-x	1	x	1	x	1
tooth pasts						1	1	1				
town gas, coal gas, illuminated gas (natural gas see later)		3	3	3	1	1	1	1	x	1	2	1
train-oil	1	1	2	2	1	1	1	1	2	1	2	
transformer oils	2	2	x	x	1	3	3	1	2 to 3	1	x	1
tributyl phosphate (TBP)	x	x	x	x	x	x	1	1	x	1	1	1
trichloro acetic acid (TCA)	x	x	x	x	3	2	1 to 2	1	x		3	1
trichloroethane (methylchloroform)	x	x	x	x	1	3	x	1	x	1	2	1
trichloroethylene (ethylene trichloride)	x	x	x	x	1 to 2	x	x	1	x	1	2	1
trichloromethane (chloroform)	x	x	x	x	1	x	x	1	x	1	x	3
tricresyl phosphate	x	x	3	x	1 to 2	x	3	1	3	1	1	3
triethanolamine	x	x	1	2 to 3	1	x	1	1	2	1	1	1
triethylamine	2	2	x		x	2	1	1	2	1	1	1
triethylene glycol (triglycol)	2	2	2	1	1			1			1	
trioctyl phosphate	x	x	3	x	x	x	1	1	x	1	1	1
trisodium phosphate	3	3	1	1	1	1	1	1	1	1	1	1
tung oil	3	2	3	3	1	3	2	1	x	1	2	
turpentine (-oil)	3	x	x	x	1	x	x	1	x	1	3-x	1
turpentine, surrogate, mineral	1 to 2	1 to 2	x	x	1	3	1 to 2	1			x	
urine	3	1	1	1	1	1	1	1	1	1	1	1
varnish	3	2	x	x	1	x	1	1	x		x	
vaseline see oils u. greases, mineral												1
vegetable oils	1-2	1-2	2-3	2	1	2	2-3	1	2-3	1	2	1
vinegar*1	x	3	1	1	1	2	1	1	2	1	1	1
vinyl acetate (acetic acid vinyl ester)	x	x	x	1	2	x	1	1	x	1	1	1
vinyl chloride (chloroethene), monomer	x	x	x	x	1	x	x	1	x	1	2	x
vitamin C	2-3	1			1	1	1					
vitriol oil (oleum)	x	x	x	x	1	x	x	1	x	1	x	x
vitriol blue (copper sulphate)	2	1	1	2	1	1	1	1	1	1	1*	
washing agent synth. (detergent) 20°C	3	2	1	1	1	1	1	1	2	1	1	
water:	3	2	1	1	1	1	1	1	1	1	1	1

*) at +20 °C ambient temperature

*1) as foodstuff, please order food-grade quality versions

*2) please ask for our detailed consultation

* registered trademark of El du Pont des Nemours and Company or one of its subsidiaries

1
2
3
4
5
6
7
8
9
10
11
12
13
14
15
16

Chemical Resistance

1 = excellent resistance

3 = medium resistance

2 = good resistance

x = non-resistant

	PUR-Ester	PUR-Ether	Silicone	Hypalon*	Viton*	PVC	PE	PTFE	Neoprene*	Kapton*	TPV	PE-EL
-aqua regia	x	x	3	3	2	2 to 3	2	1	3	1	3	
-condensed, distilled, desalinated or demineralised does not effect polymers but polymers effect water												
-drinking- or mineral water, without additives*1 to°C	25	60	120	100	150	70	80	200		200	100	
-mineral water CO2 saturated*1	3	1	1	1	1	1	1	1	1	1	1	
-seawater	x	2	1	1	1	1	1	1	1	1	1	1
weathering	2	1	1	1	1	1	2	1	1	1	1 bis 2	
white spirit (petroleum spirit, solvent naphta)	1 to 2	1 to 2	x	x	1	3	1 to 2	1			x	1
wines red and white*1	3	1	1	1	1	1	2	1	2 to 3	1	1	1
wood oil	3	2	3	3	1	3	2	1	x	1	2	2
wool grease (lanoline)	1	1	3	3	1	2	2	1	3	1	2	1
xylamon (wood protection)	3	3	x	x	2			1			x	
xylene	x	x	x	x	1 to 2	x	2 to 3	1	x	1	x	1
xylidine (dimethyl aniline)	x	x	1	1	1			1	1		3	
zinc acetate, aqu.	x	x	x	x	x		1	1	x	1	1	1
zinc chloride, aqu.	2 to 3	2	1	1	1 to 2	1	1	1	1	1	1	1
zinc sulphate, aqu.	2 to 3	2	1	1	1	1	1	1	1	1	1	1

The values listed in the table "Chemical Resistance" are based on the qualified listings of various raw materials suppliers, our own tests, as well as customer experience reports. These are explicitly intended as a guideline only and have been compiled according to the best of our knowledge; they are, however - especially in consideration of third parties - non-binding. Risks in regard to applicability, proper use and suitability remain the responsibility of the purchaser.

*) at +20 °C ambient temperature

*1) as foodstuff, please order food-grade quality versions

*2) please ask for our detailed consultation

* registered trademark of El du Pont des Nemours and Company or one of its subsidiaries



Locations

Germany

Masterflex SE
 Willy-Brandt-Allee 300
 45891 Gelsenkirchen
 Tel +49 209 97077-0
 Fax +49 209 97077-33
 www.Masterflex.de

Germany

Matzen & Timm GmbH
 Nordportbogen 2
 22848 Norderstedt
 Tel +49 40 853212-0
 Fax +49 40 8587-23
 www.Matzen-Timm.de

Czech Republic

Masterflex Česko s.r.o.
 Průmyslová 917
 34815 Planá
 Czech Republic
 Tel +420 374 6294-69
 Fax +420 374 6310-31
 www.Masterflex.cz

USA

Masterduct, Inc.
 5235 Ted Street
 P.O. Box 40727, ZIP 77240
 Houston, TX 77040, USA
 Tel +1 713 46257-79
 Fax +1 713 93984-41
 www.Masterduct.com

China

Masterflex Hoses
 (Kunshan) Co. Ltd.
 395 Jiande Road
 Zhangpu Town, Kunshan,
 Jiangsu Province
 P.R. China, 215321
 Tel +86 512 5795-2886
 Fax +86 512 5795-2787
 www.Masterflex.cn

Germany

Novoplast Schlauchtechnik GmbH
 In den Langen Stücken 6
 38820 Halberstadt
 Tel +49 3941 6869-0
 Fax +49 3941 6869-40
 www.Schlauchtechnik.de

Germany

APT
 Advanced Polymer Tubing GmbH
 Borsigstr. 13-15
 41469 Neuss
 Tel +49 2137 109737-0
 www.APTubing.de

Sweden

Masterflex Scandinavia AB
 Kabelgatan 13
 43437 Kungsbacka
 Sweden
 Tel +46 300 1717-0
 www.Masterflex.se

Brazil

Masterduct Brasil
 Comercio de Dutos LTDA.
 Rua dos Estados,
 18-Villa Industrial
 06516-310- Santana de
 Parnaíba-SP, Brasil
 Tel +55 11 415151-00
 Fax +55 11 415125-96
 www.Masterduct.com.br

Asia-Pacific

Masterflex Asia Pte. Ltd.
 German Centre for Industry
 and Trade Pte Ltd.
 25 International Business Park
 04-60A German Centre
 Singapore 609916
 Tel +65 6897 45-85
 Fax +65 6897 45-81
 www.Masterflex.asia

Germany

FLEIMA-PLASTIC GmbH
 Neustadt 2
 69483 Wald-Michelbach
 Tel +49 6207 92412-0
 Fax +49 6207 92412-30
 www.Fleima-Plastic.de

France

Masterflex SARL
 Z.A. des 2B
 01360 Béligneux, France
 Tel +33 4 780602-02
 Fax +33 4 780621-56
 www.Masterflex.fr

UK

Masterflex Technical Hoses Ltd.
 Prince of Wales Business Park,
 Vulcan Street, Oldham,
 OL 1 4ER, Lancashire, UK
 Tel +44 161 62680-66
 Fax +44 161 62690-66
 www.Masterflex-UK.com

